



Dubrovnik Senior European Cup 2026

Croatia, Dubrovnik, 28-29 Mar 2026

-60 kg

Seniors (15)

POOL A

| | | |
|--|--------------------|-----|
| | AKKUS Mihrac | TUR |
| | KUNYIK Botond | HUN |
| | SAGASTEGUI Eduardo | MEX |

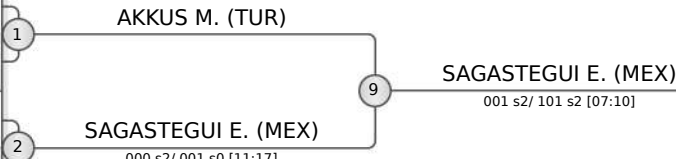

POOL B

| | | |
|--|-------------------|-----|
| | HOWARD Benjamin | GER |
| | ABUBAKAROV Mansur | AUT |
| | ADRIF Nordine | GBR |
| | GAUCH David | SUI |

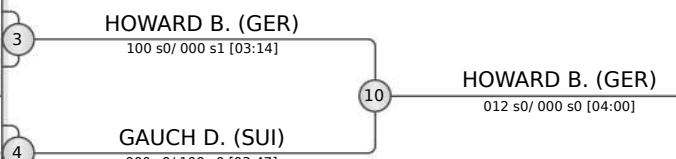

POOL C

| | | |
|--|--------------------|-----|
| | KARAHAN Emirhan | TUR |
| | SOLDO Marin | CRO |
| | GALO Bence | HUN |
| | STANDKE Maximilian | GER |

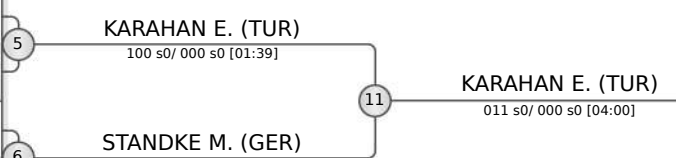

POOL D

| | | |
|--|---------------------|-----|
| | WAIZENEGGER Jesse | SUI |
| | ESENBAGA Yunus Emre | TUR |
| | VIKOL Adam | HUN |
| | BOLATBEKOV Damir | KAZ |

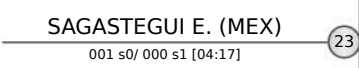
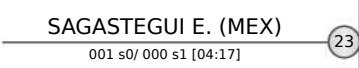
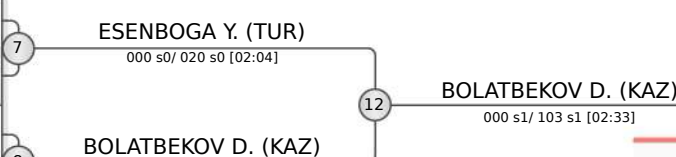

FINAL RESULTS

- SAGASTEGUI Eduardo MEX
- BOLATBEKOV Damir KAZ
- KARAHAN Emirhan TUR
- HOWARD Benjamin GER
- GAUCH David SUI
- STANDKE Maximilian GER
- KUNYIK Botond HUN
- ESENBAGA Yunus Emre TUR

REPECHAGE

| | |
|---------------------|----|
| KUNYIK B. (HUN) | 13 |
| AKKUS M. (TUR) | 13 |
| ABUBAKAROV M. (AUT) | 14 |
| GAUCH D. (SUI) | 14 |
| SOLDO M. (CRO) | 15 |
| STANDKE M. (GER) | 15 |
| VIKOL A. (HUN) | 16 |
| ESENBAGA Y. (TUR) | 16 |

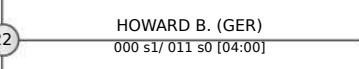
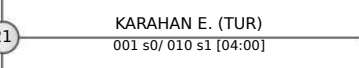
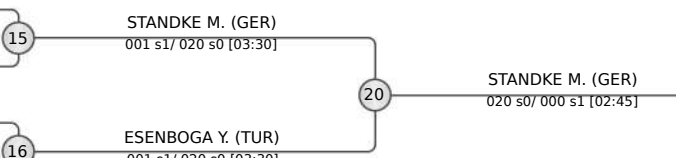
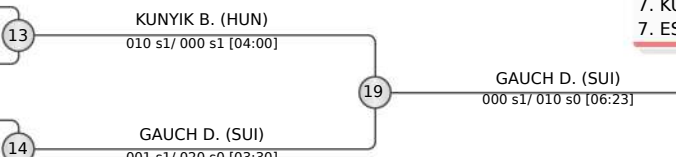



Dubrovnik Senior European Cup 2026

Croatia, Dubrovnik, 28-29 Mar 2026

-66 kg
Seniors (24)

POOL A

| | | |
|--|--------------------|-----|
| | GUTMAN Guy | ISR |
| | WAIZENEGGER Freddy | SUI |
| | SINANOVIC Emil | MNE |
| | CEKIM Firat | TUR |
| | WEISSER Patrick | GER |
| | TOMASEVIC Marko | CRO |

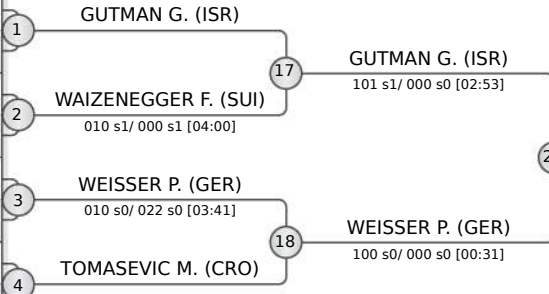

POOL B

| | | |
|--|--------------------|-----|
| | KOLLAR Sebestyen | HUN |
| | JEREMIC Matija | SRB |
| | BUTUCI Kristian | CRO |
| | BACHMANN Gaetan | SUI |
| | RAMIREZ Juan Pablo | MEX |
| | VAREY Gregg | GBR |

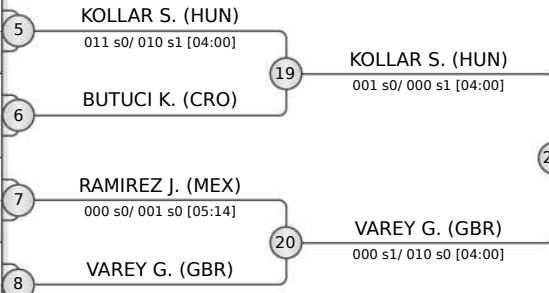

POOL C

| | | |
|--|-------------------------------|-----|
| | KLACAR Dani | CRO |
| | BOULAICH Moubarak Abou Alfida | MAR |
| | MAJOR Adam | HUN |
| | IDIGOV Abdul-Rahman | AUT |
| | KUJANHAARA Joonatan | FIN |
| | FLUM Fabio | SUI |

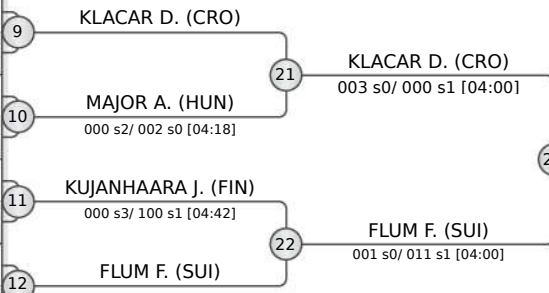

POOL D

| | | |
|--|-----------------------|-----|
| | KOKALJ Gasper | SLO |
| | BURK Lenny Linus | GER |
| | DVORACEK Antonin | CZE |
| | KLIMKIEWICZ Krzysztof | POL |
| | ROZGA Roko | CRO |
| | SEILKHAN Kanat | KAZ |

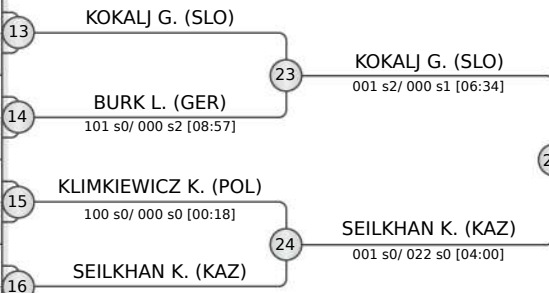

REPECHAGE

| | |
|----|----------------------|
| 29 | WAIZENEGGER F. (SUI) |
| 30 | JEREMIC M. (SRB) |
| 31 | MAJOR A. (HUN) |
| 32 | KLIMKIEWICZ K. (POL) |
| 33 | WEISSER P. (GER) |
| 34 | JEREMIC M. (SRB) |
| 35 | MAJOR A. (HUN) |
| 36 | KLIMKIEWICZ K. (POL) |

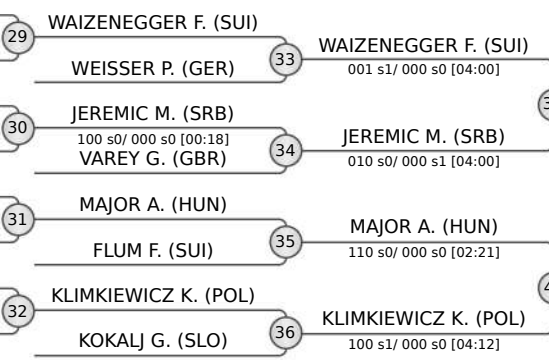

| FINAL RESULTS | |
|---------------|-----------------------|
| 1. | GUTMAN Guy |
| 2. | KLACAR Dani |
| 3. | WAIZENEGGER Freddy |
| 3. | KOLLAR Sebestyen |
| 5. | SEILKHAN Kanat |
| 5. | MAJOR Adam |
| 7. | JEREMIC Matija |
| 7. | KLIMKIEWICZ Krzysztof |





Dubrovnik Senior European Cup 2026

Croatia, Dubrovnik, 28-29 Mar 2026

-73 kg

Seniors (35)

POOL A

| | | |
|--|-----------------|-----|
| | GOBERT Maxime | FRA |
| | KOZUL Petar | BIH |
| | ELDIC Ivan | CRO |
| | ZHAKASHOV Aibek | KAZ |
| | MENZL Nikolas | GER |
| | KATIC Ivan | CRO |
| | ALLAN Finlay | GBR |
| | JOVANOVIC Filip | SRB |

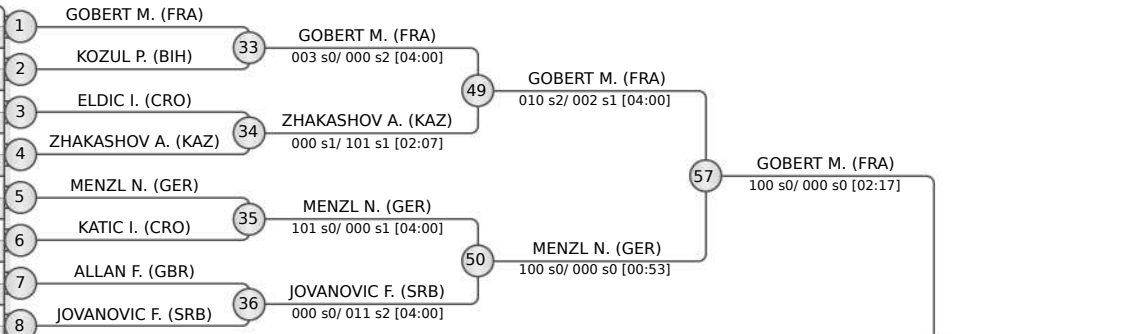

POOL B

| | | |
|--|--------------------------|-----|
| | KASERER Alexander | AUT |
| | GOKCEN Niyazi | TUR |
| | HAMZA Mohammad Bakhtiyar | IRT |
| | KAZIMIERCZAK Adam | POL |
| | WAIZENEGGER John | SUI |
| | TOMIC Stiv | CRO |
| | LEHNIGER Joseph | GER |
| | UVEGES Attila | HUN |
| | TOPALOVIC Darko | SRB |

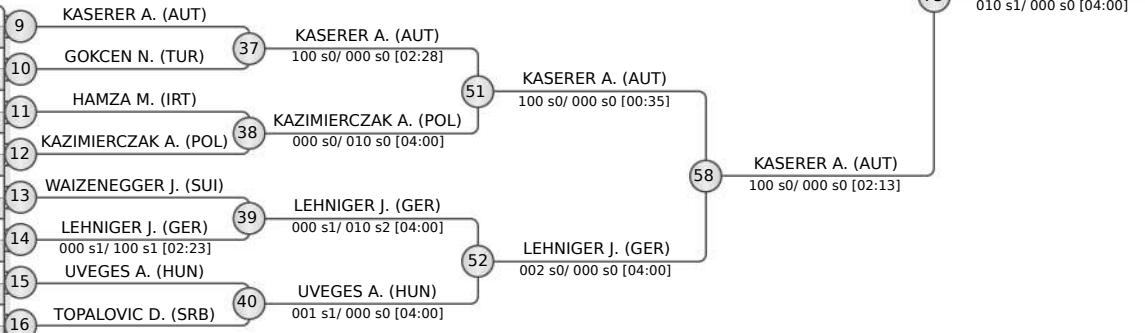

POOL C

| | | |
|--|----------------------|-----|
| | MEYER Luc | GER |
| | BARCZIKAY Akos | HUN |
| | OLUJIC Mario | CRO |
| | TAAVITSAINEN Jesper | FIN |
| | KATIC Luka | CRO |
| | SHAMSHAYEV Daniyar | KAZ |
| | BEN SAAD Firas | AUT |
| | SCHONENBERGER Naahum | SUI |
| | LOJANICIC Marko | SRB |

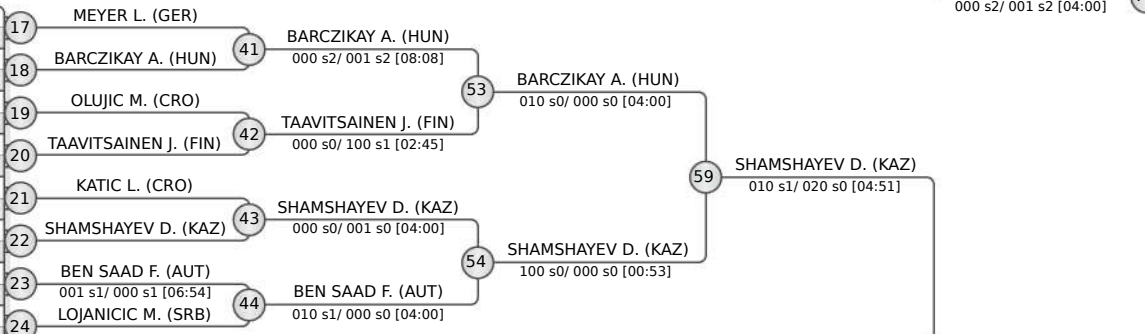

POOL D

| | | |
|--|---------------------|-----|
| | KLACAR Robert | CRO |
| | MACAR Uros | SRB |
| | HIMMELSPACH Yannick | GER |
| | PREVE Eliot | FRA |
| | GOKER Yucel | TUR |
| | STOSIC Mateja | SRB |
| | NASIROVS Abulfazs | LAT |
| | KALASZ Adam | HUN |
| | VUKOVIC Aleksandar | BIH |

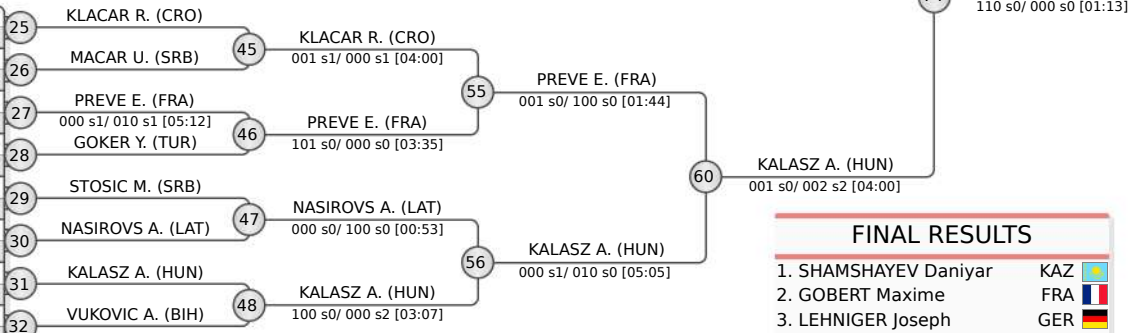

| FINAL RESULTS | | |
|---------------|--------------------|-----|
| 1. | SHAMSHAYEV Daniyar | KAZ |
| 2. | GOBERT Maxime | FRA |
| 3. | LEHNIGER Joseph | GER |
| 3. | PREVE Eliot | FRA |
| 5. | KALASZ Adam | HUN |
| 5. | KASERER Alexander | AUT |
| 7. | ZHAKASHOV Aibek | KAZ |
| 7. | BARCZIKAY Akos | HUN |

REPECHAGE

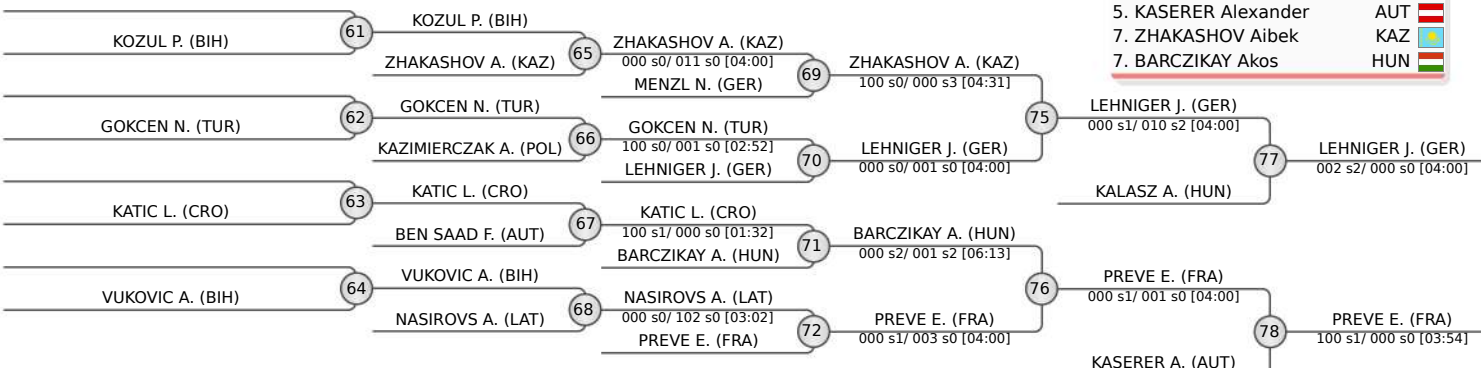



Dubrovnik Senior European Cup 2026

Croatia, Dubrovnik, 28-29 Mar 2026

-81 kg

Seniors (43)

POOL A

| | | | |
|---|--------------------------|----|---------------------|
| 1 | KOC Muhammed (TUR) | 33 | KOC M. (TUR) |
| 2 | HRANJEC Adrian (CRO) | | DJURDJEVIC A. (SRB) |
| 3 | DJURDJEVIC Adrian (SRB) | | GARDASEVIC N. (MNE) |
| 4 | GARDASEVIC Nebojsa (MNE) | 34 | GOSPODINOV D. (BUL) |
| 5 | GOSPODINOV Dimitar (BUL) | | BELLINI A. (ITA) |
| 6 | BELLINI Alessandro (ITA) | 35 | SOJKA A. (CZE) |
| 7 | SOJKA Alexandr (CZE) | | HEGEDUS B. (HUN) |
| 8 | ZELLMANN Fabian (AUT) | | HEGEDUS B. (HUN) |
| | HEGEDUS Bendeguz (HUN) | 36 | NEUMANN E. (GBR) |
| | NEUMANN Eryk (GBR) | | |

POOL B

| | | | |
|----|-----------------------------|----|------------------------|
| 9 | GREEN Joshua (IRL) | 37 | TSURKAN I. (SLO) |
| 10 | TSURKAN Igor (SLO) | | DEMETER M. (HUN) |
| 11 | GURGEN Erman (TUR) | | BERC J. (CRO) |
| 12 | DEMETER Marcell (HUN) | 38 | BUBALO A. (SRB) |
| 13 | CLOCCHIATTI Daniel (ITA) | | BORCHASHVILLI M. (AUT) |
| 14 | BERC Josip (CRO) | 39 | BORCHASHVILLI M. (AUT) |
| 15 | BUBALO Aleksa (SRB) | | KAUN S. (GER) |
| 16 | BORCHASHVILLI Magamed (AUT) | 40 | ABITULY K. (KAZ) |
| | KAUN Sebastian (GER) | | ABITULY Kanat (KAZ) |
| | HOPE Isaac (GBR) | | |
| | ABITULY Kanat (KAZ) | | |

POOL C

| | | | |
|----|--------------------------|----|-----------------------|
| 17 | ELEZ Vuk (SRB) | 41 | ELEZ V. (SRB) |
| 18 | PLANTAK Aljaz (SLO) | | GUNICS E. (HUN) |
| 19 | GUNICS Endre (HUN) | 42 | CUHADAR A. (TUR) |
| 20 | BARDUS Iacopo (ITA) | | STANIMIROVIC V. (SRB) |
| 21 | CUHADAR Ahmet (TUR) | 43 | SOC M. (MNE) |
| 22 | STANIMIROVIC Vukan (SRB) | | CORLUKA R. (CRO) |
| 23 | SOC Mihail (MNE) | 44 | CORLUKA R. (CRO) |
| 24 | RAMIREZ Jose (MEX) | | STOPP P. (HUN) |
| | CORLUKA Roko (CRO) | | |
| | GRABNER Erik (AUT) | | |
| | STOPP Patrik (HUN) | | |

POOL D

| | | | |
|----|------------------------|----|--------------------|
| 25 | DREXLER Phillip (GER) | 45 | DEGALLIER Y. (SUI) |
| 26 | DEGALLIER Yanis (SUI) | | ARGOV O. (ISR) |
| 27 | NUZZO Davide (ITA) | 46 | ZELTNER M. (AUT) |
| 28 | ARGOV Or (ISR) | | MLADY Petr (CZE) |
| 29 | ZELTNER Michael (AUT) | 47 | DEMETER B. (HUN) |
| 30 | MLADY Petr (CZE) | | IVOVIC F. (SRB) |
| 31 | MASON Joseph (GBR) | 48 | IVOVIC F. (SRB) |
| 32 | DEMETER Bendeguz (HUN) | | KRMEK R. (CRO) |
| | ATAC Omer Faruk (TUR) | | |
| | IVOVIC Filip (SRB) | | |
| | KRMEK Roko Ivan (CRO) | | |

REPECHAGE

| | | | | | | | | | |
|----|---------------------|----|---------------------|----|-----------------------|----|---------------------|----|------------------------|
| 61 | DJURDJEVIC A. (SRB) | 65 | GARDASEVIC N. (MNE) | 69 | GARDASEVIC N. (MNE) | 75 | GARDASEVIC N. (MNE) | 77 | GARDASEVIC N. (MNE) |
| 62 | BUBALO A. (SRB) | 66 | ABITULY K. (KAZ) | 70 | TSURKAN I. (SLO) | 76 | DEMETER B. (HUN) | 78 | BORCHASHVILLI M. (AUT) |
| 63 | PLANTAK A. (SLO) | 67 | CUHADAR A. (TUR) | 71 | STANIMIROVIC V. (SRB) | | | | |
| 64 | DEMETER B. (HUN) | 68 | IVOVIC F. (SRB) | 72 | DEGALLIER Y. (SUI) | | | | |

| FINAL RESULTS | |
|---------------|-----------------------------|
| 1. | MLADY Petr (CZE) |
| 2. | KOC Muhammed (TUR) |
| 3. | GARDASEVIC Nebojsa (MNE) |
| 3. | BORCHASHVILLI Magamed (AUT) |
| 5. | ELEZ Vuk (SRB) |
| 5. | DEMETER Bendeguz (HUN) |
| 7. | TSURKAN Igor (SLO) |
| 7. | STANIMIROVIC Vukan (SRB) |





Dubrovnik Senior European Cup 2026

Croatia, Dubrovnik, 28-29 Mar 2026

-90 kg

Seniors (39)

POOL A

| | | |
|-----|---------------------|---|
| ITA | MINCINESI Cristiano | 1 |
| GER | SCHREDER Leon | 2 |
| AUT | WEITZBAUER Niklas | 3 |
| BIH | ILIC Vuk | 3 |
| CRO | ROZGA Bruno | 4 |
| MNE | SINANOVIC Nenad | 5 |
| KAZ | KHAMZA Didar | 6 |
| HUN | MIKLOSVOLGYI Daniel | 7 |
| CRO | GRSETIC Nikola | 8 |

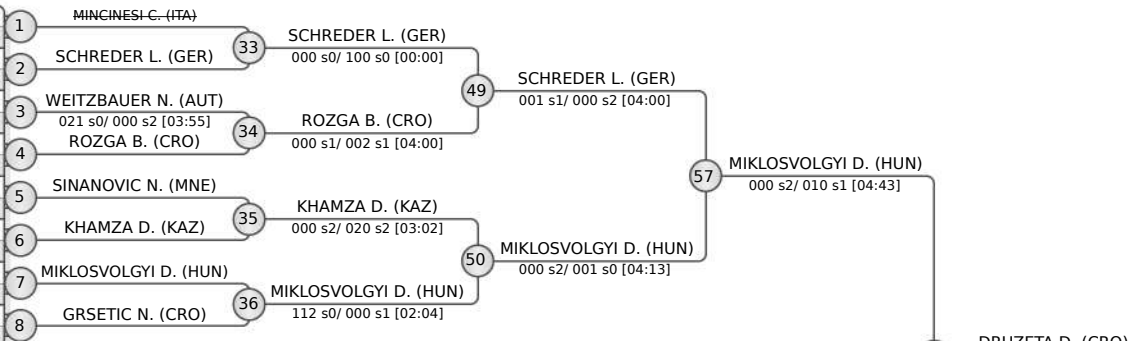

POOL B

| | | |
|-----|---------------------------|----|
| CRO | DRUZETA Dominik | 9 |
| GBR | O'SULLIVAN Nathan | 10 |
| FRA | METIFIOT Hugo | 10 |
| CRO | BRNADA Ivan | 11 |
| SRB | MIHAJLOVIC Milan | 12 |
| IRL | GLEESON Bearach | 13 |
| GER | OHNEISER Lukas | 14 |
| HUN | KISS Levente | 14 |
| CRO | STRAZA Tin | 15 |
| RSA | BREYTENBACH Thomas-Laszlo | 16 |

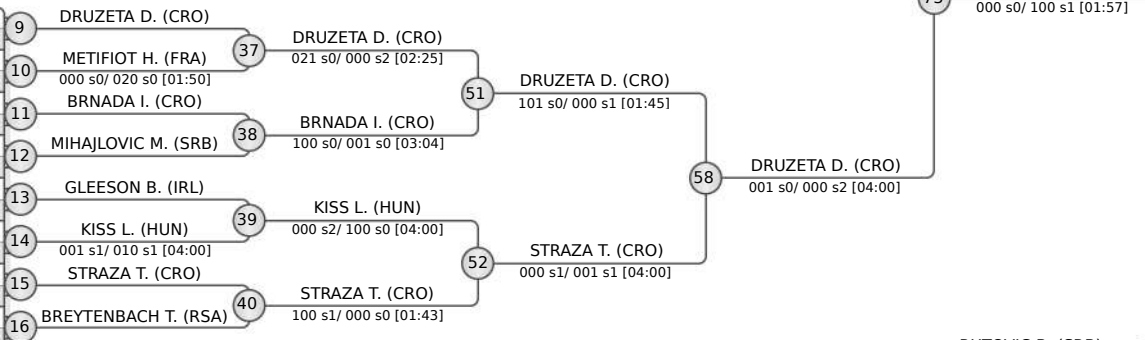

POOL C

| | | |
|-----|-----------------------|----|
| FRA | BENEZRA Yoann | 17 |
| CRO | SUFAJ Ardian | 18 |
| HUN | PINTER Bulcsu | 18 |
| ISR | MAOR Gal | 19 |
| GER | SEIFERT Markus | 20 |
| CRO | KONCILIJA Dan | 21 |
| CZE | MUSIL Radomir | 22 |
| AUT | BRETSCHNEIDER Gabriel | 23 |
| ITA | GAMBA Giacomo | 23 |
| GBR | SEY Jared | 24 |

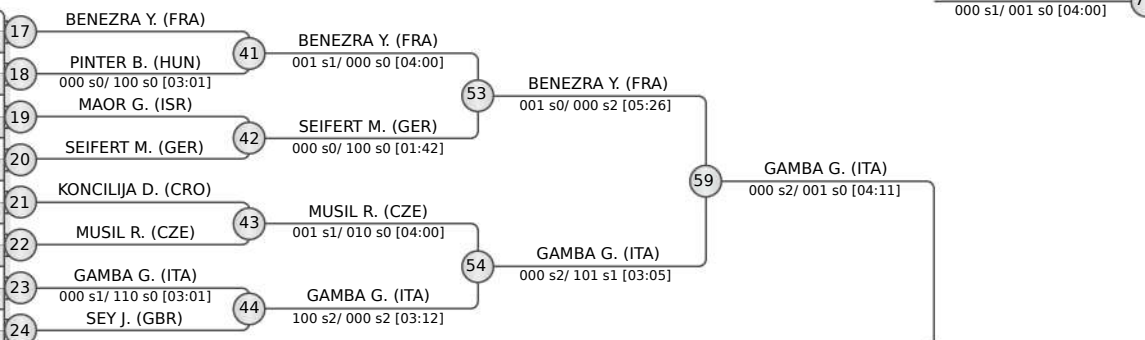

POOL D

| | | |
|-----|-----------------------|----|
| CRO | MRKOVIC Lovre | 25 |
| ITA | RAFFAELI Andrea | 26 |
| SUI | OULEVEY Thien | 26 |
| CRO | BOZIC Marko | 27 |
| SRB | RUTOVIC Boris | 28 |
| FRA | MITROVIC Aleksa | 29 |
| MNE | CUPIC Lazar | 30 |
| TUR | ARI Emir Selim | 30 |
| CRO | ZOROTOVIC Luka | 31 |
| AUT | ISLAMHANOV Saif-Islam | 32 |

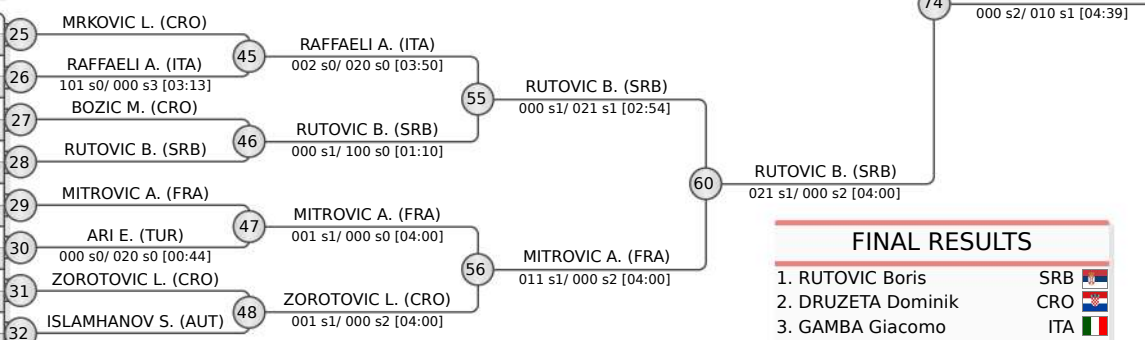

| FINAL RESULTS | |
|---------------|---------------------------|
| 1. | RUTOVIC Boris (SRB) |
| 2. | DRUZETA Dominik (CRO) |
| 3. | GAMBA Giacomo (ITA) |
| 3. | MITROVIC Aleksa (FRA) |
| 5. | KHAMZA Didar (KAZ) |
| 5. | MIKLOSVOLGYI Daniel (HUN) |
| 7. | METIFIOT Hugo (FRA) |
| 7. | MUSIL Radomir (CZE) |

REPECHAGE

| | |
|----|-------------------|
| 61 | GRSETIC N. (CRO) |
| 62 | METIFIOT H. (FRA) |
| 63 | SEY J. (GBR) |
| 64 | BOZIC M. (CRO) |

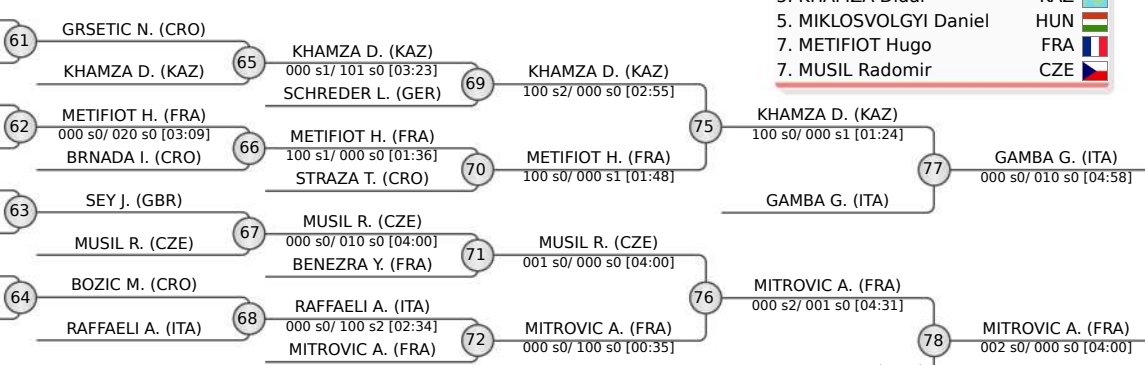



Dubrovnik Senior European Cup 2026

Croatia, Dubrovnik, 28-29 Mar 2026

-100 kg

Seniors (24)

POOL A

| | | |
|--|----------------------|-----|
| | ACCOGLI Daniele | ITA |
| | MANDIC Kazimir | CRO |
| | NIEDERDORFER Michael | AUT |
| | MARTINOVIC Andrija | MNE |
| | OHAT Zalan | HUN |
| | NESTOR Kevin | SWE |

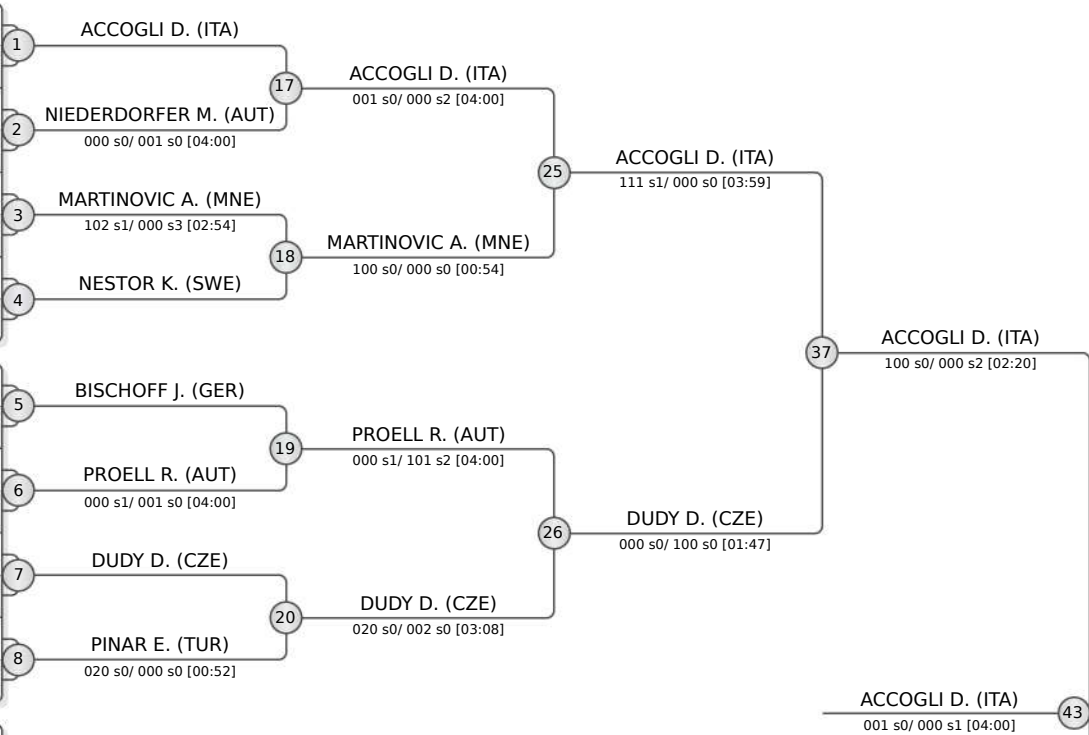

POOL B

| | | |
|--|-------------------|-----|
| | BISCHOFF Jonathan | GER |
| | YESTAY Yermukhan | KAZ |
| | PROELL Ronald | AUT |
| | DUDY David | CZE |
| | PINAR Enes | TUR |
| | MICAI Luka | CRO |

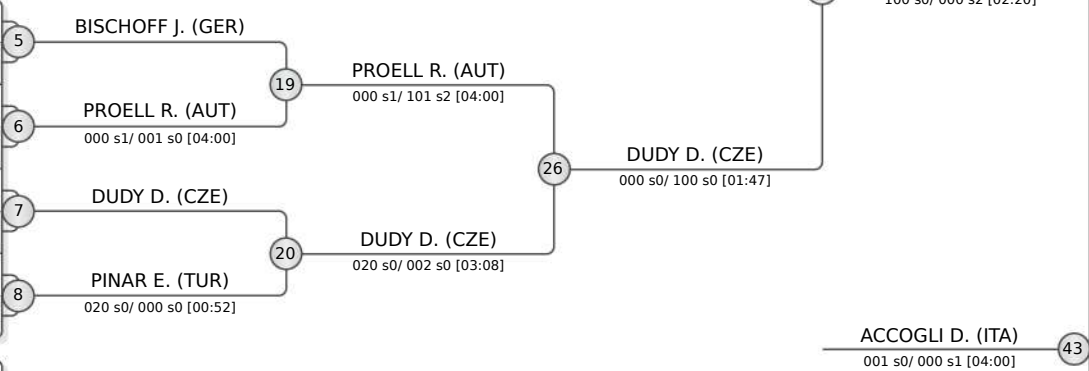

POOL C

| | | |
|--|----------------------|-----|
| | TOMIC Aleksandar | MNE |
| | DJORDJEVIC Djordjije | SRB |
| | NAGLADZE Giorgi | AUT |
| | ROZGA Ivan | CRO |
| | LAKOS Mate | HUN |
| | SAVIC Dimitrije | BIH |

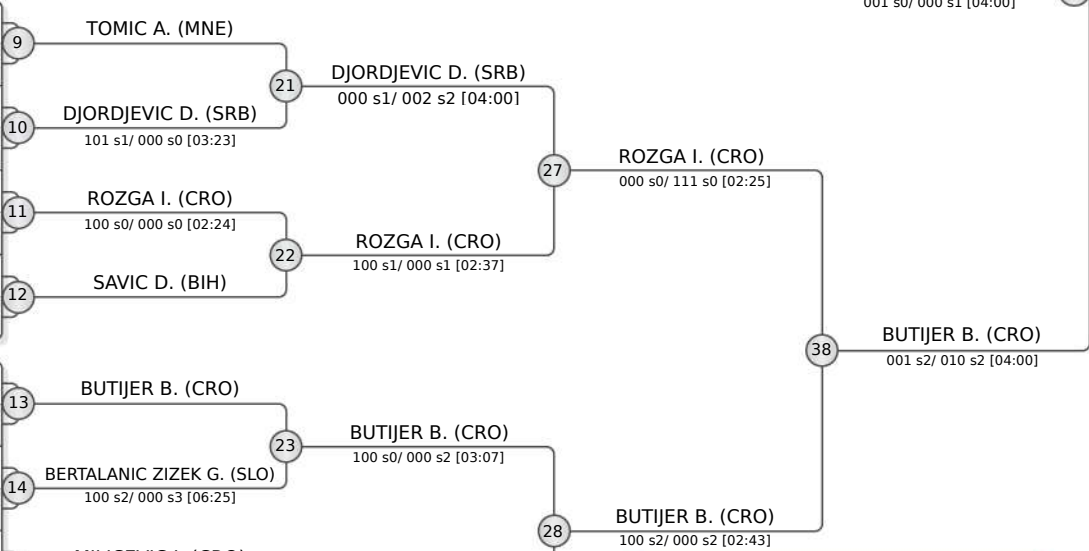

POOL D

| | | |
|--|----------------------|-----|
| | BUTIJER Borna | CRO |
| | BERTALANIC ZIZEK Gal | SLO |
| | LHOTZKY Frantisek | CZE |
| | KOMPE Mertcan | TUR |
| | MILICEVIC Ivan | CRO |
| | HAVASI Balint | HUN |

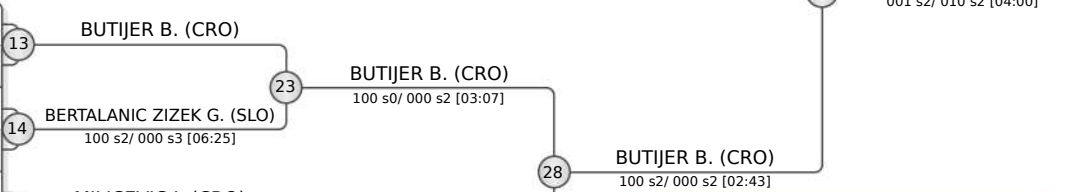

| FINAL RESULTS | | |
|---------------|----------------------|-----|
| 1. | ACCOGLI Daniele | ITA |
| 2. | BUTIJER Borna | CRO |
| 3. | PROELL Ronald | AUT |
| 3. | DUDY David | CZE |
| 5. | ROZGA Ivan | CRO |
| 5. | BERTALANIC ZIZEK Gal | SLO |
| 7. | NIEDERDORFER Michael | AUT |
| 7. | SAVIC Dimitrije | BIH |

REPECHAGE

| | |
|------------------------------|------------------------------|
| NIEDERDORFER M. (AUT) 29 | NIEDERDORFER M. (AUT) 33 |
| PINAR E. (TUR) 30 | PROELL R. (AUT) 34 |
| LAKOS M. (HUN) 31 | SAVIC D. (BIH) 35 |
| BERTALANIC ZIZEK G. (SLO) 32 | BERTALANIC ZIZEK G. (SLO) 36 |

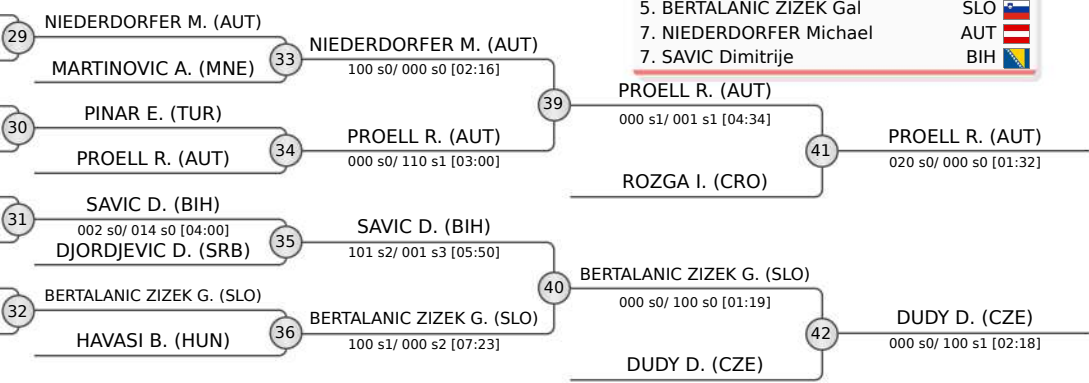



Dubrovnik Senior European Cup 2026

Croatia, Dubrovnik, 28-29 Mar 2026

+100 kg

Seniors (14)

POOL A

| | | |
|--|---------------------|-----|
| | BORCHASHVILLI Movli | AUT |
| | IVANKOVIC Luka | CRO |
| | DOBOS Levente | HUN |

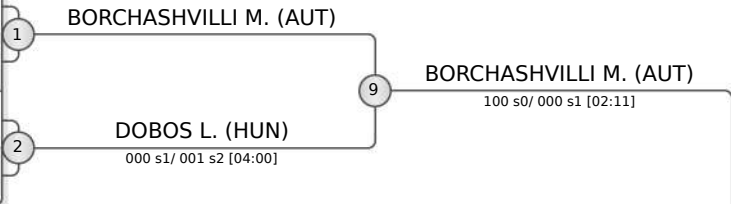

POOL B

| | | |
|--|----------------|-----|
| | VUKIC Slobodan | MNE |
| | MALJEVIC Vidak | SRB |
| | PEKOVIC Jovan | MNE |
| | ZALOGLU Mikail | TUR |

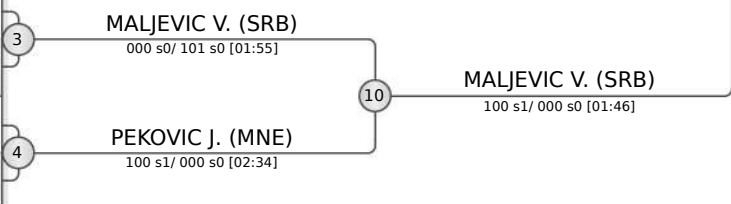

POOL C

| | | |
|--|--------------------|-----|
| | ERGIN Recep | TUR |
| | WELLER-HENRY James | GBR |
| | JASEK Vaclav | CZE |

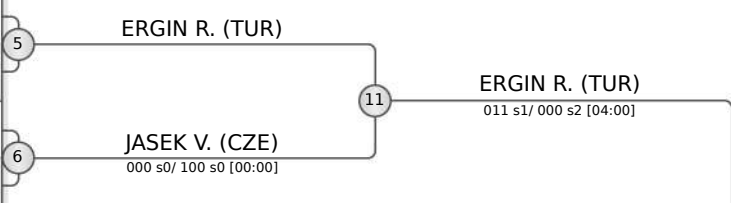

POOL D

| | | |
|--|--------------------|-----|
| | DUBRETA Anto | MNE |
| | VR LJIC Rino | BIH |
| | STOSIC Andrija | SRB |
| | OMBOLI-CSOK Renato | HUN |

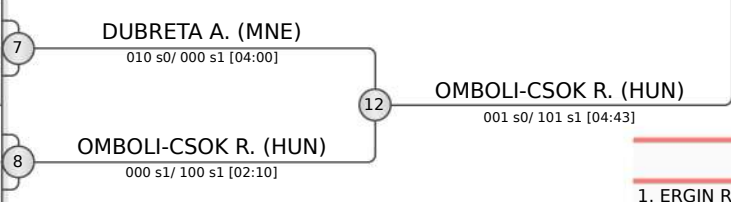

REPECHAGE

| | |
|------------------|----|
| DOBOS L. (HUN) | 13 |
| VUKIC S. (MNE) | 14 |
| PEKOVIC J. (MNE) | 14 |
| JASEK V. (CZE) | 15 |
| STOSIC A. (SRB) | 16 |
| DUBRETA A. (MNE) | 16 |

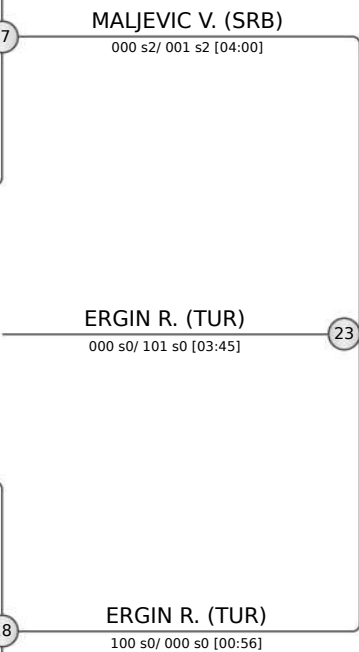
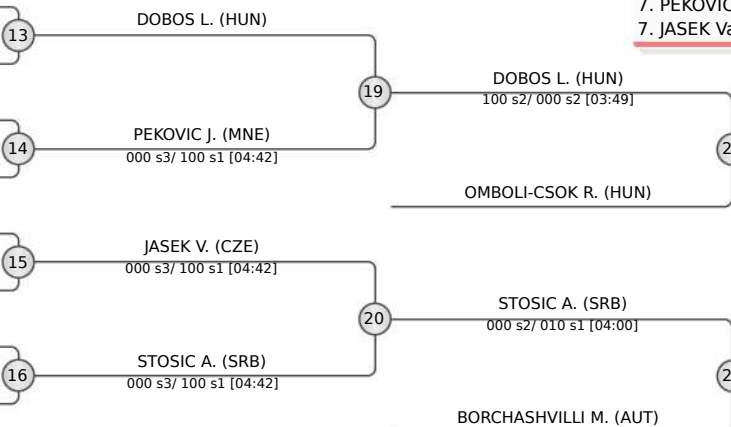

FINAL RESULTS

| | | |
|------------------------|-----|--|
| 1. ERGIN Recep | TUR | |
| 2. MALJEVIC Vidak | SRB | |
| 3. DOBOS Levente | HUN | |
| 3. BORCHASHVILLI Movli | AUT | |
| 5. OMBOLI-CSOK Renato | HUN | |
| 5. STOSIC Andrija | SRB | |
| 7. PEKOVIC Jovan | MNE | |
| 7. JASEK Vaclav | CZE | |

