



Paks Junior European Cup 2025

Hungary, Paks, 12-13 Jul 2025

-60 kg

Juniors (30)

POOL A

	VELAZCO Christopher	USA
	ISAYEV Askhab	BEL
	GALABOV Denis	BUL
	TAMARY Ben	ISR
	SASSI Thomas	ITA
	VIKOL Adam	HUN
	BASSI Thibaud	SUI

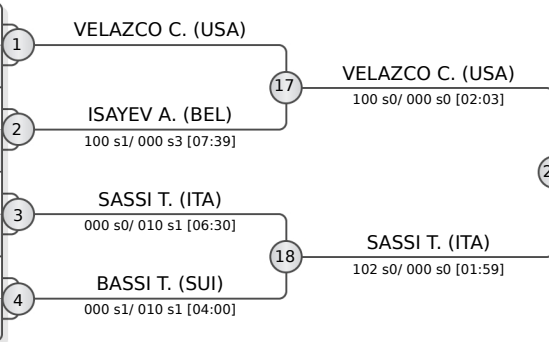

POOL B

	MISIROV Asadbek	UZB
	SMEJKAL Stepan	CZE
	GALO Bence	HUN
	CROCIANI Francesco	ITA
	MOSOI Tudor	ROU
	MEHDITACHE Ido	ISR
	BANNISTER Jack	AUS
	IURTAEV Ivan	IJF

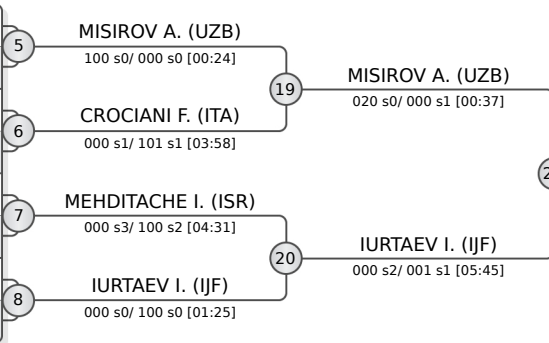

POOL C

	YANG Jonathan	USA
	ISAKOV Nikola	SRB
	LEE Casey	AUS
	NAVON Maayan	ISR
	TINELLI Mario	ITA
	BLAZIC Gal	SLO
	KUNYIK Botond	HUN

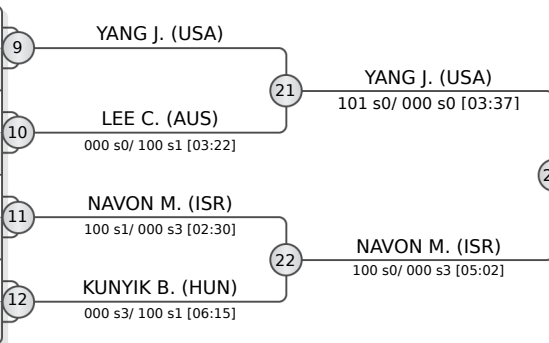

POOL D

	SAMPINO Francesco	ITA
	KIBAROGLU Ramazan	TUR
	SZEKELY Botond	ROU
	KUCHKAROV Samariddin	UZB
	ASHPIZ Izhak	ISR
	GOGOV Anzor	IJF
	COHEN Adrian	USA
	PEETERS Milan	BEL

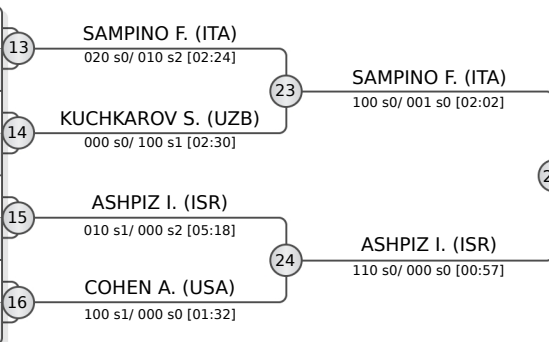

REPECHAGE

ISAYEV A. (BEL) 29	ISAYEV A. (BEL)
BANNISTER J. (AUS) 30	BANNISTER J. (AUS)
MEHDITACHE I. (ISR) 31	MEHDITACHE I. (ISR)
LEE C. (AUS) 32	LEE C. (AUS)
KIBAROGLU R. (TUR) 33	KIBAROGLU R. (TUR)
KUCHKAROV S. (UZB) 34	KUCHKAROV S. (UZB)

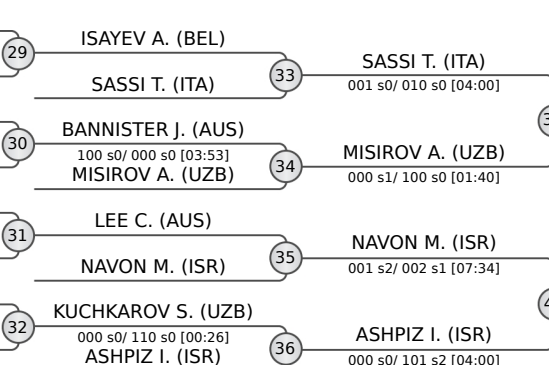

FINAL RESULTS	
1.	IURTAEV Ivan IJF
2.	SAMPINO Francesco ITA
3.	MISIROV Asadbek UZB
3.	ASHPIZ Izhak ISR
5.	YANG Jonathan USA
5.	VELAZCO Christopher USA
7.	SASSI Thomas ITA
7.	NAVON Maayan ISR



Paks Junior European Cup 2025

Hungary, Paks, 12-13 Jul 2025

-66 kg

Juniors (58)

POOL A

1	HAMROYEV D. (UZB)	33	HAMROYEV D. (UZB)
2	PARCHIEV A. (IJF)	010 s1/ 000 s2 [04:00]	001 s0/ 000 s1 [04:55]
3	SHAI O. (ISR)	000 s0/ 012 s0 [04:00]	001 s1/ 000 s1 [04:00]
4	MOLNAR Z. (HUN)	001 s2/ 000 s1 [04:00]	000 s0/ 000 s0 [00:00]
5	LAUTER V. (HUN)	000 s2/ 001 s0 [05:30]	000 s0/ 000 s0 [02:10]
6	KASPARAVICIUS N. (LTU)	001 s1/ 010 s1 [04:00]	000 s0/ 010 s1 [04:00]
7	PETROVIC P. (SRB)	000 s2/ 110 s1 [02:45]	
8	DULARIDZE G. (GEO)	000 s0/ 010 s1 [04:00]	

POOL B

9	SHEYNFELD L. (USA)	37	SHEYNFELD L. (USA)
10	ROSU Y. (ISR)	100 s0/ 000 s0 [00:11]	020 s0/ 000 s0 [01:47]
11	JORGIC M. (SRB)	000 s1/ 002 s0 [04:00]	002 s2/ 000 s1 [04:00]
12	MUCIK H. (TUR)	000 s1/ 101 s0 [03:06]	000 s3/ 100 s2 [05:47]
13	KLODA G. (ISR)		100 s1/ 000 s3 [03:32]
14	KOLLAR S. (HUN)	100 s1/ 000 s3 [03:32]	103 s0/ 000 s1 [03:22]
15	MORARU A. (MDA)	103 s0/ 000 s1 [03:22]	101 s0/ 000 s0 [02:18]
16	BORENOVIC B. (SRB)	000 s0/ 110 s0 [00:27]	000 s0/ 110 s0 [00:27]

POOL C

17	YANG J. (USA)	41	KOLOVERDOV P. (IJF)
18	KOLOVERDOV P. (IJF)	100 s0/ 000 s1 [01:20]	000 s0/ 100 s0 [02:05]
19	NARKUS G. (LTU)	000 s0/ 101 s0 [01:09]	102 s0/ 000 s0 [01:34]
20	DZHAMALDINOV A. (BEL)	000 s0/ 111 s0 [03:49]	011 s1/ 010 s0 [04:33]
21	MATOS DA FONSECA T. (POR)	000 s0/ 010 s1 [04:00]	001 s2/ 012 s1 [04:00]
22	SIMIC V. (SRB)	001 s2/ 012 s1 [04:00]	020 s0/ 000 s0 [01:29]
23	BAECHLE F. (GER)	020 s0/ 000 s0 [01:29]	100 s1/ 000 s0 [02:22]
24	FLUM F. (SUI)	100 s0/ 000 s1 [06:46]	100 s0/ 000 s0 [00:44]

POOL D

25	TOURNIER T. (AUS)	45	MASLAC R. (SVK)
26	MASLAC R. (SVK)	000 s0/ 011 s1 [04:00]	001 s0/ 011 s0 [04:52]
27	JEREMIC M. (SRB)	000 s1/ 001 s1 [04:00]	000 s0/ 100 s0 [00:43]
28	SHERER Z. (ISR)	001 s1/ 000 s0 [05:56]	100 s1/ 000 s3 [06:45]
29	POLIKEVICIUS S. (LTU)	011 s0/ 000 s0 [04:00]	001 s2/ 000 s1 [05:23]
30	ANNINO N. (ITA)	000 s1/ 100 s1 [04:30]	011 s0/ 000 s0 [04:00]
31	KOPECKY M. (CZE)	001 s1/ 000 s2 [05:02]	000 s0/ 000 s1 [02:30]
32	IVTCHENKO M. (GER)	000 s1/ 001 s0 [04:00]	000 s1/ 100 s2 [03:59]

REPECHAGE

61	PARCHIEV A. (IJF)	65	PARCHIEV A. (IJF)
62	BORENOVIC B. (SRB)	66	KOLLAR S. (HUN)
63	COHEN S. (ISR)	67	COHEN S. (ISR)
64	MAJOR A. (HUN)	68	MASLAC R. (SVK)

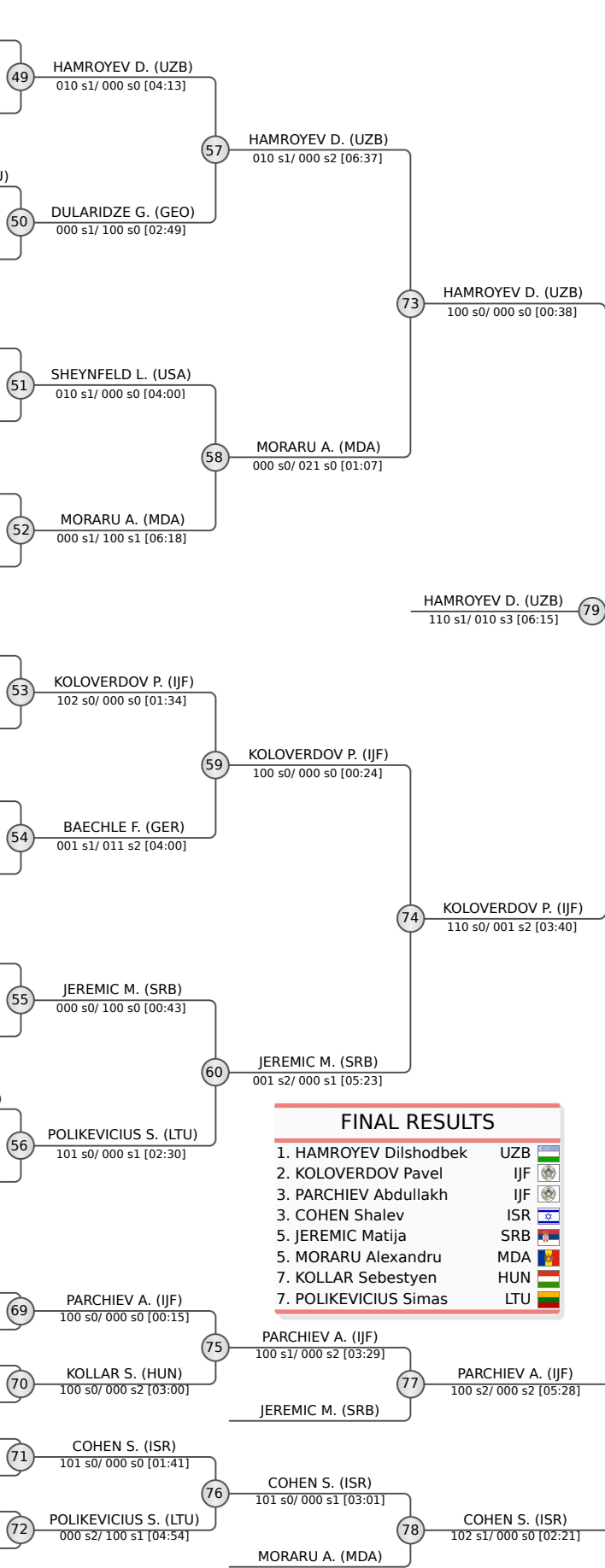

FINAL RESULTS		
1.	HAMROYEV Dilshodbek	UZB
2.	KOLOVERDOV Pavel	IJF
3.	PARCHIEV Abdullakh	IJF
3.	COHEN Shalev	ISR
5.	JEREMIC Matija	SRB
5.	MORARU Alexandru	MDA
7.	KOLLAR Sebestyen	HUN
7.	POLIKEVICIUS Simas	LTU



Paks Junior European Cup 2025

Hungary, Paks, 12-13 Jul 2025

-73 kg
Juniors (65)

POOL A

1	CRAMP Thomas (AUS)
2	DAVIDOV Timur (IJF)
3	LE BRIS Lowan (CAN)
4	RAFFAY Levente (HUN)
5	TERNULLO Domenico (USA)
6	CSAJBOK Barnabas (HUN)
7	TODOROV Nikolay (BUL)
8	MECILOSEK Fran (SLO)
9	MOLOSHYK Danylo (UKR)
10	MLADENOVIC Andrija (SRB)
11	RAES Fabio (NED)
12	MARUFOV Muhridin (UZB)
13	GABRALIYEV Akraman (AUT)
14	FERENCZ Barnabas (HUN)
15	NUNES DOS SANTOS Kevin (LUX)
16	PICCOLO Gabriele (ITA)
17	VARMUZKA Matej (CZE)

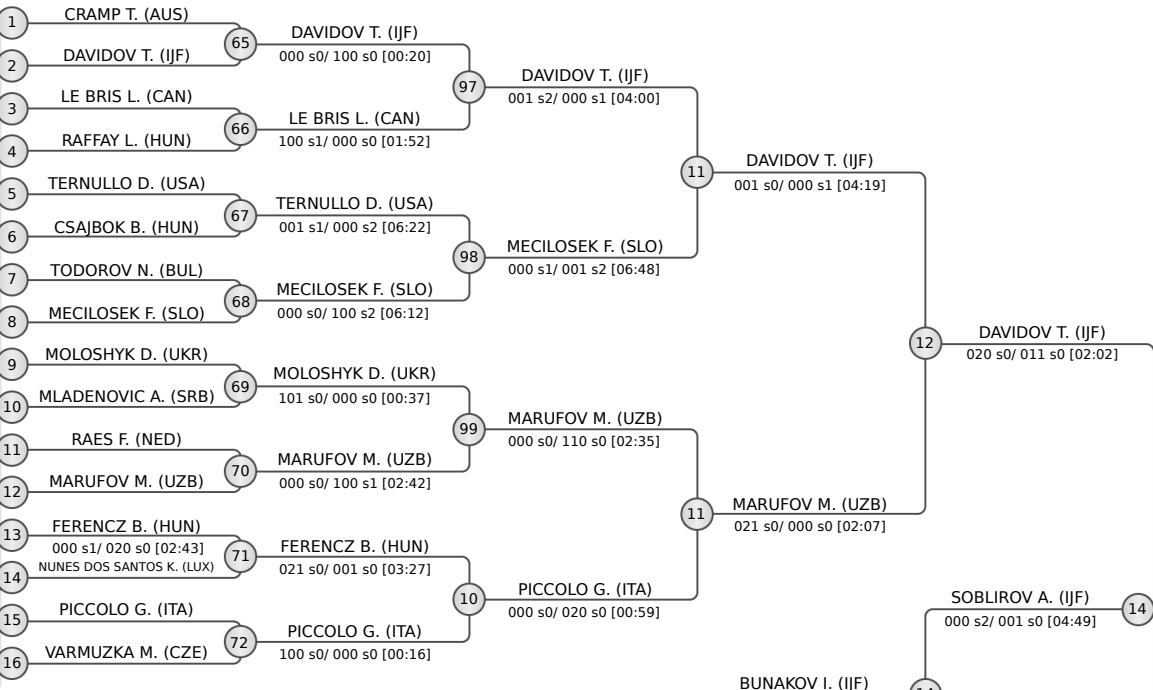

POOL B

17	CROITORU Renat (MDA)
18	GEORGARAS Ioannis (GRE)
19	TOTH Barna (HUN)
20	PANDEV Ozbi (SLO)
21	MAZZOLA Salvatore (ITA)
22	VELICKOVIC Bogdan (SRB)
23	AKOTO Raphael (GER)
24	MURESAN Marius (ROU)
25	UVEGES Attila (HUN)
26	TURGUTLU Abdullah (TUR)
27	RASMUSSEN Niklas (AUT)
28	SOBLIROV Atmir (IJF)
29	HADZI-VELJKOVIC Borna (CRO)
30	DJORDJEVIC Jovan (SRB)
31	BULOCINIC Tom (ISR)
32	FISCHER Basile (SUI)

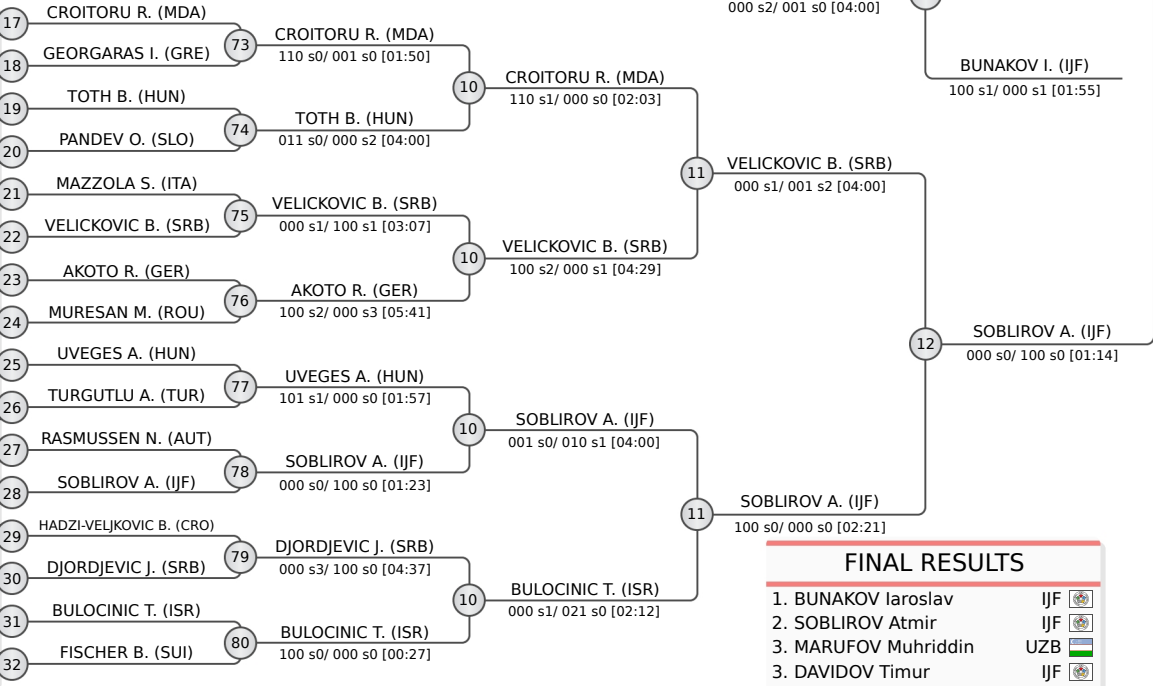

FINAL RESULTS		
1.	BUNAKOV Iaroslav	IJF
2.	SOBLIROV Atmir	IJF
3.	MARUFOV Muhridin	UZB
3.	DAVIDOV Timur	IJF
5.	BOSIS Federico	ITA
5.	TAVOLETTA Lucio	ITA
7.	UVEGES Attila	HUN
7.	MORITZ Ohad	ISR

REPECHAGE

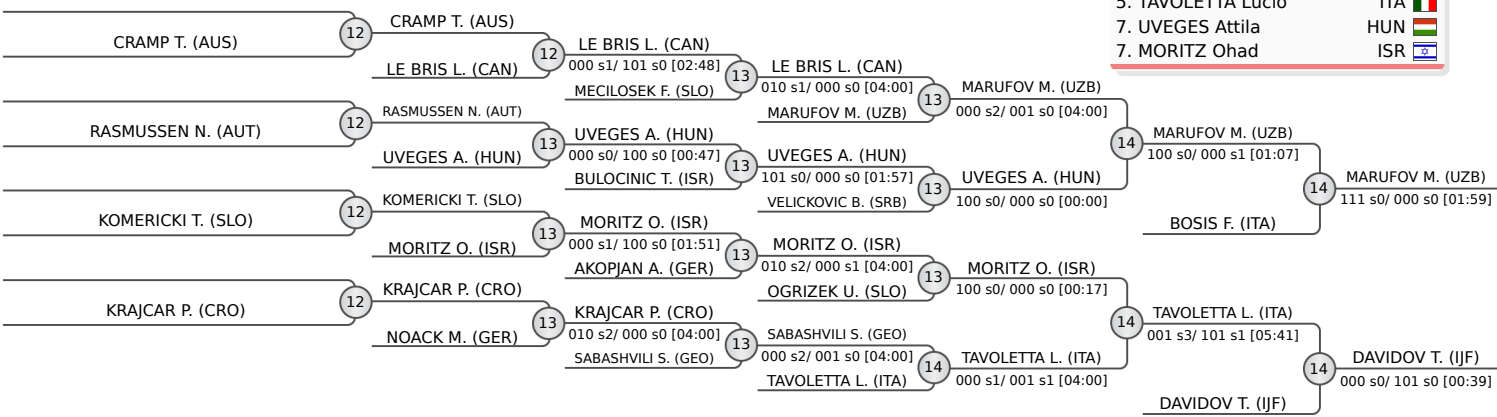



Paks Junior European Cup 2025

Hungary, Paks, 12-13 Jul 2025

-73 kg

Juniors (65)

POOL C

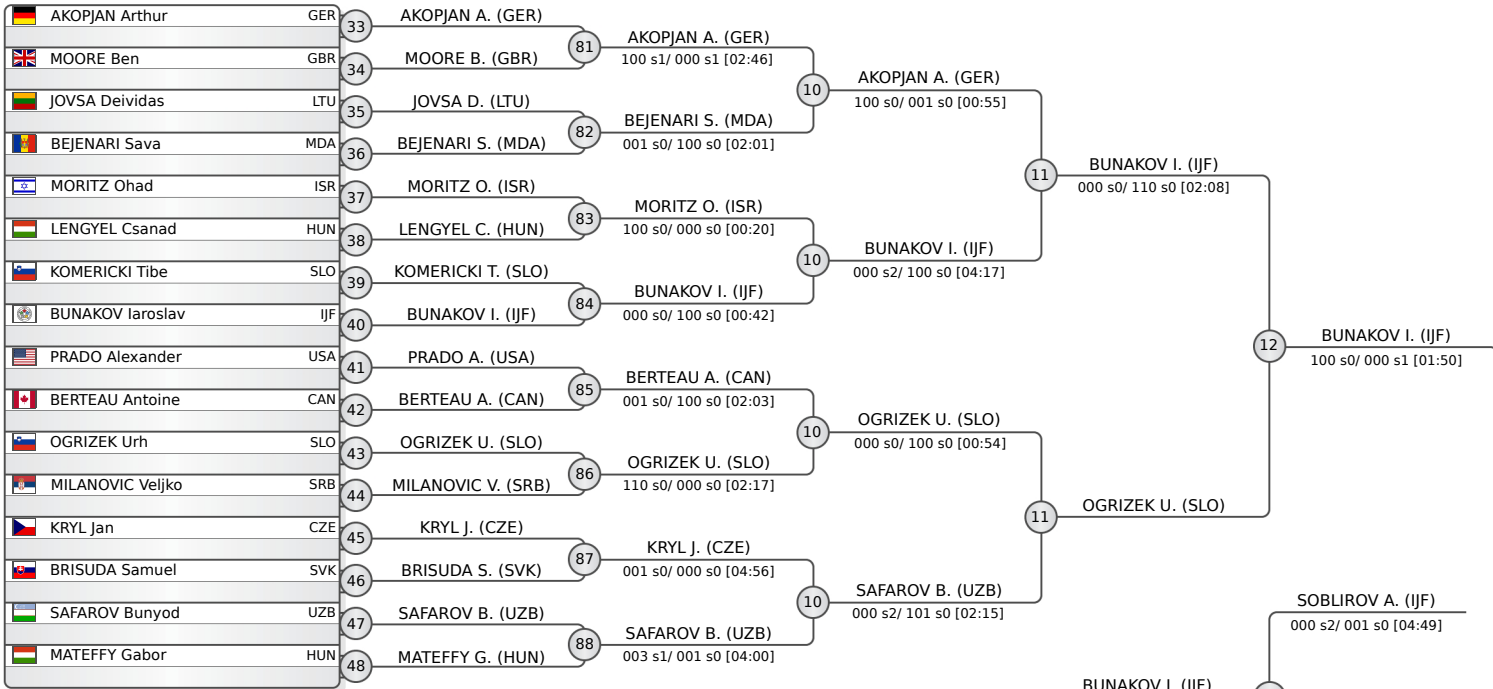

POOL D

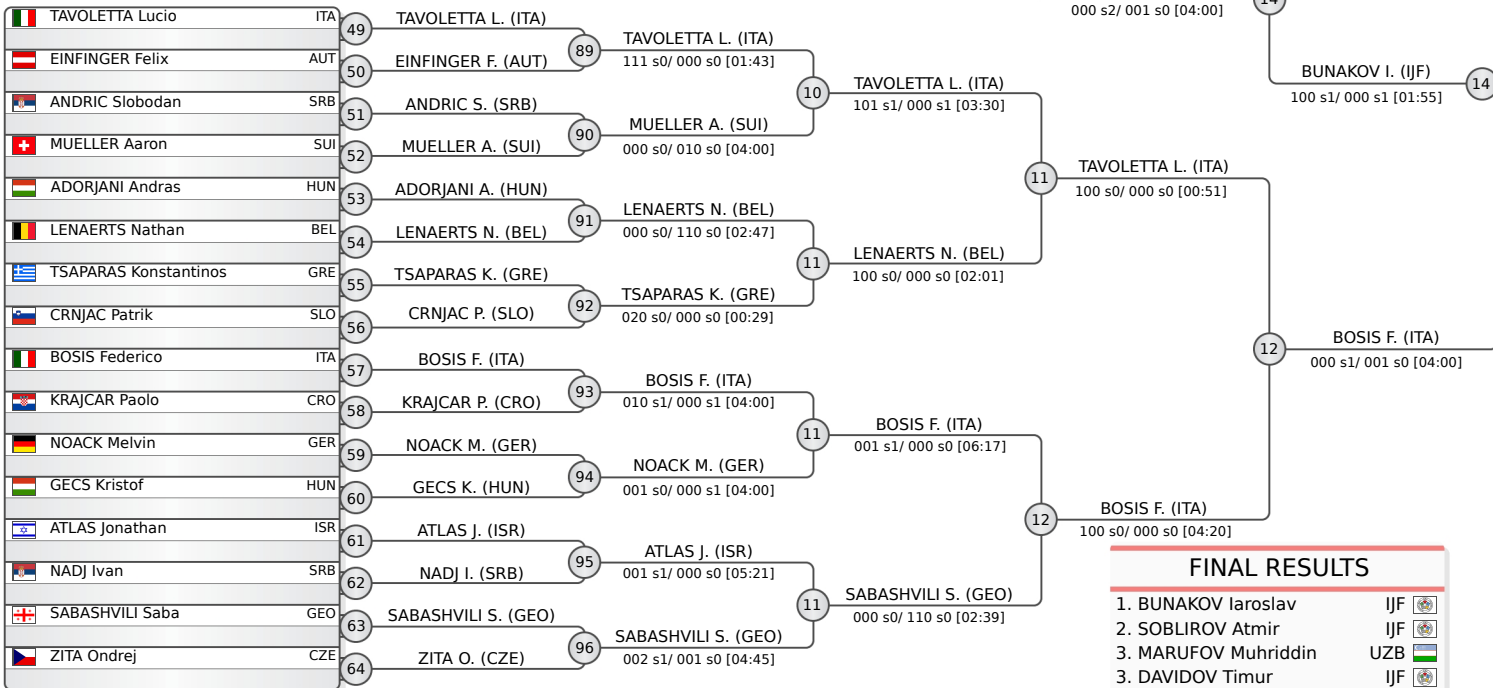

FINAL RESULTS	
1.	BUNAKOV Iaroslav IJF
2.	SOBLIROV Atmir IJF
3.	MARUFOV Muhridin UZB
3.	DAVIDOV Timur IJF
5.	BOSIS Federico ITA
5.	TAVOLETTA Lucio ITA
7.	UVEGES Attila HUN
7.	MORITZ Ohad ISR

REPECHAGE

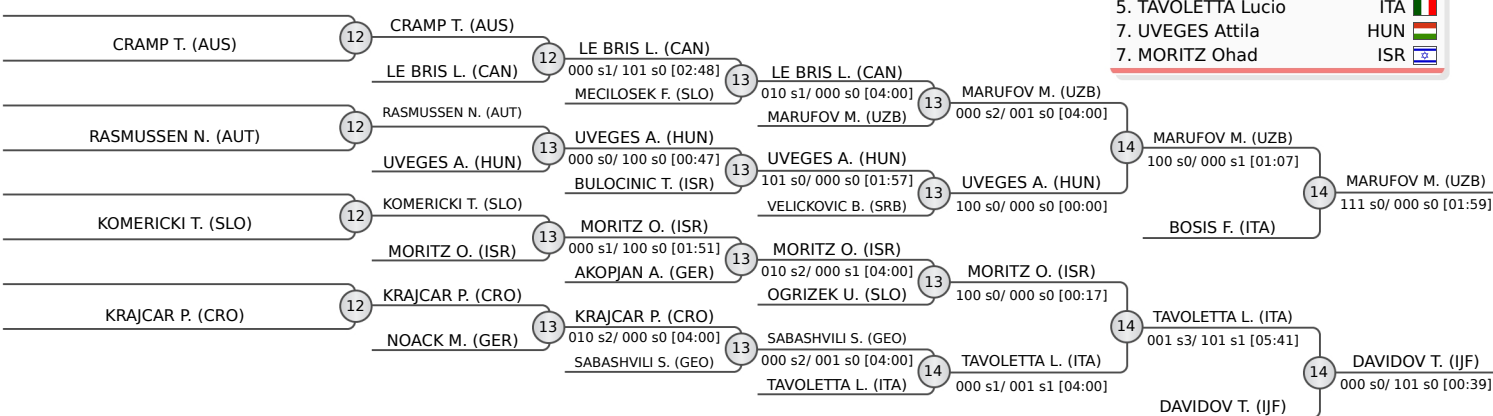



Paks Junior European Cup 2025

Hungary, Paks, 12-13 Jul 2025

-81 kg

Juniors (59)

POOL A

1	TSURKAN Igor (UKR)	1	TSURKAN I. (UKR)
2	PERTELSON Kristofer (FIN)	2	GRAHOVAC D. (SRB)
3	GRAHOVAC Dusan (SRB)	3	KUCERA K. (CZE)
4	KUCERA Kristian (CZE)	4	FRIDMAN ZILBERSTEIN R. (ISR)
5	GREINER Christian (AUT)	5	BAPTISTA M. (POR)
6	HORVATH Nandor (HUN)	6	LAKK Z. (HUN)
7	FRIDMAN ZILBERSTEIN Reem (ISR)	7	D URBANO A. (ITA)
8	DURDEVIC Adrian (BIH)	8	CHYZHEVSKYI G. (MDA)
9	BAPTISTA Manuel (POR)	9	CHYZHEVSKYI G. (MDA)
10	DE OLIVEIRA Octavio (USA)	10	LAKK Z. (HUN)
11	LAKK Zsombor (HU)	11	D URBANO A. (ITA)
12	RACKA Norbertas (LTU)	12	D URBANO A. (ITA)
13	D URBANO Alessandro Bruno (ITA)	13	CHYZHEVSKYI G. (MDA)
14	MOCNIK Lovro (SLO)	14	CHYZHEVSKYI G. (MDA)
15	CHYZHEVSKYI Ghenadi (MDA)	15	CHYZHEVSKYI G. (MDA)

POOL B

9	GRUJICIC Vasilije (SRB)	9	GRUJICIC V. (SRB)
10	DEATH Jamie (GBR)	10	DEATH J. (GBR)
11	DINEV Aleksandar (BUL)	11	TEKUZHEV A. (IJF)
12	COHEN Aiden (USA)	12	PINTER B. (HUN)
13	TEKUZHEV Astemir (IJF)	13	PINTER B. (HUN)
14	PINTER Bulcsu (HUN)	14	MUXIBIDDINOV S. (UZB)
15	GRABNER Erik (AUT)	15	MUXIBIDDINOV S. (UZB)
16	MUXIBIDDINOV Samariddin (UZB)	16	MUXIBIDDINOV S. (UZB)
17	LADO Akos (ROU)	17	LADO A. (ROU)
18	PERECZ Mark (HUN)	18	LALEIKE Y. (GER)
19	LALEIKE Yoshiya (GER)	19	LALEIKE Y. (GER)
20	PAJOVIC Petar (MNE)	20	KAVNIK M. (SLO)
21	NORBERG Alexander (SWE)	21	KAVNIK M. (SLO)
22	KAVNIK Maj (SLO)	22	KAVNIK M. (SLO)

POOL C

17	PARICHE Luis (VEN)	17	PARICHE L. (VEN)
18	PRIKEL Zsombor (HUN)	18	POLISHCHUK M. (FIN)
19	POLISHCHUK Matfei (FIN)	19	ALEKSANOVI S. (ITA)
20	CHAYNIKOV Dmitry (SLO)	20	ALEKSANOVI S. (ITA)
21	ALEKSANOVI Saba (ITA)	21	GROSMAN Y. (ISR)
22	GROSMAN Yair (ISR)	22	GROSMAN Y. (ISR)
23	GOEBEL Matti (GER)	23	TURLUEV A. (IJF)
24	TURLUEV Akhmed (IJF)	24	TURLUEV A. (IJF)
25	VUCKOVIC Andrej (SRB)	25	DELIEUTRAZ M. (SUI)
26	MILLER Evan (USA)	26	DELIEUTRAZ M. (SUI)
27	DELIEUTRAZ Milo (SUI)	27	PROELL M. (AUT)
28	STOPP Patrik (HUN)	28	PROELL M. (AUT)
29	PROELL Michael (AUT)	29	ARI E. (TUR)
30	ARI Emir Selim (TUR)	30	ARI E. (TUR)
31	KOENIG Joshua (AUS)	31	ARI E. (TUR)

POOL D

25	SIMIN Mihajlo (SRB)	25	SIMIN M. (SRB)
26	KOMIC Oliver (SLO)	26	BERTALAN B. (HUN)
27	BERTALAN Balazs (HUN)	27	PEATICOVSKI A. (MDA)
28	KNOPPERSEN Kai (NED)	28	PEATICOVSKI A. (MDA)
29	PEATICOVSKI Andrei (MDA)	29	HOPE I. (GBR)
30	HOPE Isaac (GBR)	30	HOPE I. (GBR)
31	PUSHKAROV Denys (SVK)	31	SHULGIN D. (USA)
32	SHULGIN Daniel (USA)	32	SHULGIN D. (USA)
33	MIKLOSVOLGYI Mate (HUN)	33	WEITZBAUER N. (AUT)
34	ASPELIN Kim (SWE)	34	WEITZBAUER N. (AUT)
35	WEITZBAUER Niklas (AUT)	35	WEITZBAUER N. (AUT)
36	SAHIR Stanislav (UKR)	36	MIHALY H. (ROU)
37	MIHALY Hunor (ROU)	37	MIHALY H. (ROU)
38	POKK Patrik (HUN)	38	NEYOLOV A. (CAN)
39	NEYOLOV Artem (CAN)	39	NEYOLOV A. (CAN)

REPECHAGE

61	GRAHOVAC D. (SRB)	61	GRAHOVAC D. (SRB)
62	LADO A. (ROU)	62	LADO A. (ROU)
63	CHAYNIKOV D. (SLO)	63	GROSMAN Y. (ISR)
64	GROSMAN Y. (ISR)	64	BERTALAN B. (HUN)
65	FRIDMAN ZILBERSTEIN R. (ISR)	65	FRIDMAN ZILBERSTEIN R. (ISR)
66	LADO A. (ROU)	66	KAVNIK M. (SLO)
67	CHAYNIKOV D. (SLO)	67	GRUJICIC V. (SRB)
68	GROSMAN Y. (ISR)	68	HOPE I. (GBR)
69	GRAHOVAC D. (SRB)	69	GRAHOVAC D. (SRB)
70	BAPTISTA M. (POR)	70	KAVNIK M. (SLO)
71	GRAHOVAC D. (SRB)	71	TURLUEV A. (IJF)
72	BAPTISTA M. (POR)	72	NEYOLOV A. (CAN)
73	GRAHOVAC D. (SRB)	73	GRAHOVAC D. (SRB)
74	KAVNIK M. (SLO)	74	GRAHOVAC D. (SRB)
75	GRAHOVAC D. (SRB)	75	GRAHOVAC D. (SRB)
76	TURLUEV A. (IJF)	76	TURLUEV A. (IJF)
77	TURLUEV A. (IJF)	77	TURLUEV A. (IJF)
78	NEYOLOV A. (CAN)	78	TURLUEV A. (IJF)
79	NEYOLOV A. (CAN)	79	TSURKAN I. (UKR)

FINAL RESULTS		
1.	SIMIN Mihajlo	SRB
2.	MUXIBIDDINOV Samariddin	UZB
3.	GRAHOVAC Dusan	SRB
3.	TURLUEV Akhmed	IJF
5.	ALEKSANOVI Saba	ITA
7.	TSURKAN Igor	UKR
7.	KAVNIK Maj	SLO
7.	NEYOLOV Artem	CAN



Paks Junior European Cup 2025

Hungary, Paks, 12-13 Jul 2025

-100 kg

Juniors (26)

POOL A

	PETRE Bogdan	ROU
	RISUKHIN Bohdan	UKR
	SCHEFFEL Oliver	SVK
	FEDIN Anton	IJF
	KENDERESI Peter	HUN
	MICAI Luka	CRO
	ZOFF Gianmaria	ITA

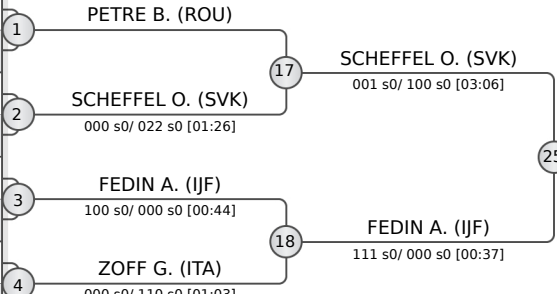

POOL B

	PALADII Yehor	CAN
	GALLUZZI Ettore	ITA
	TOTH Miron	HUN
	CANIZALEZ Gustavo	VEN
	GRAZIOSI Davide	ITA
	NASIBOV Aykhan	MDA

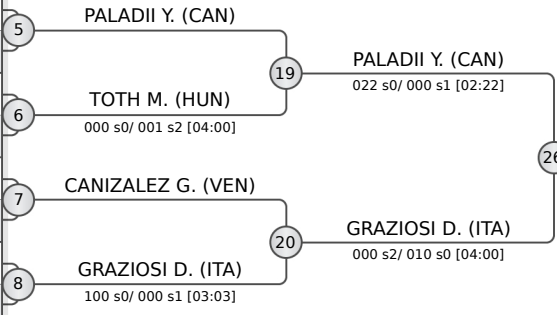

POOL C

	ZDRALE Lazar	SRB
	DA CRUZ Matteo	LUX
	CZIBULA Bernat	HUN
	ZOIROV Mukhammadali	UZB
	FIORE Francesco	ITA
	DINCA Alexandru	ROU
	TITINKIN Ivan	IJF

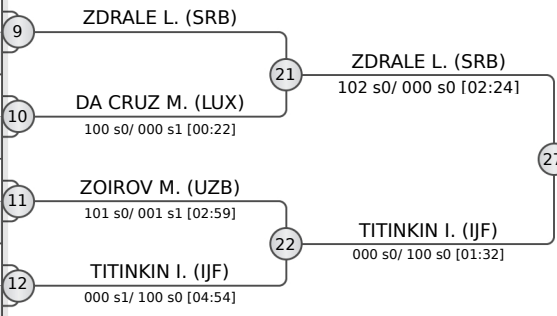

POOL D

	BUTIJER Borna	CRO
	CAPPELLO Giorgio	ITA
	DZAPKU Armin	HUN
	MALJEVIC Vidak	SRB
	BULATOVIC Pavle	MNE
	LIPIC Gabriel	SLO

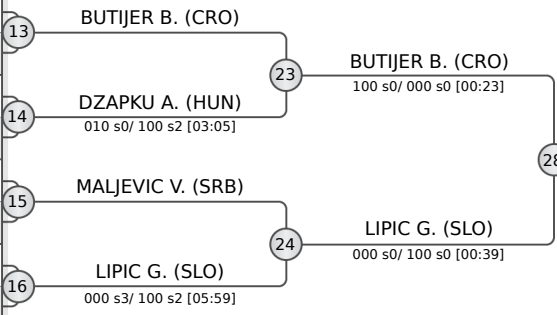

REPECHAGE

KENDERESI P. (HUN)		29	KENDERESI P. (HUN)	33	SCHEFFEL O. (SVK)
ZOFF G. (ITA)		30	TOTH M. (HUN)	34	TOTH M. (HUN)
TOZH M. (HUN)		31	ZOIROV M. (UZB)	35	ZDRALE L. (SRB)
DINCA A. (ROU)		32	MALJEVIC V. (SRB)	36	MALJEVIC V. (SRB)
ZOIROV M. (UZB)			BUTIJER B. (CRO)		
BULATOVIC P. (MNE)					
MALJEVIC V. (SRB)					

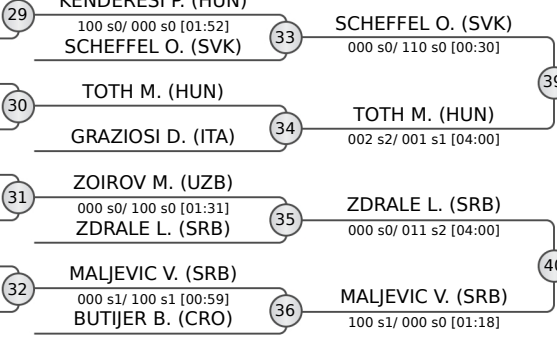

FINAL RESULTS		
1.	FEDIN Anton	IJF
2.	TITINKIN Ivan	IJF
3.	LIPIC Gabriel	SLO
3.	ZDRALE Lazar	SRB
5.	SCHEFFEL Oliver	SVK
7.	PALADII Yehor	CAN
	TOTH Miron	HUN
	MALJEVIC Vidak	SRB



Paks Junior European Cup 2025

Hungary, Paks, 12-13 Jul 2025

+100 kg

Juniors (17)

POOL A

	MESSE A-BESSONG John	CAN	1	MESSE A-BESSONG J. (CAN)
	SZEKERES Abel	HUN	2	SZEKERES A. (HUN)
	PLOSCEANU Calin	ROU	3	100 s0/ 000 s0 [01:31]
	NIKITENKO Nikita	GER	3	NIKITENKO N. (GER)
	SCHARNER Oliver	AUT	4	SCHARNER O. (AUT)

POOL B

	BOROJEVIC Mateja	SRB	5	BOROJEVIC M. (SRB)
	KATAMARDOV Bislan	IJF	6	KATAMARDOV B. (IJF)
	DOBOS Levente	HUN	7	DOBOS L. (HUN)
	TUGUI David	ROU	8	TUGUI D. (ROU)

POOL C

	DOBRE Darius	ROU	9	DOBRE D. (ROU)
	IAGAFAROV Karim	IJF	10	IAGAFAROV K. (IJF)
	KOSTANJSEK Zan	SLO	11	KOSTANJSEK Z. (SLO)
	FROSIO Edoardo	ITA	12	FROSIO E. (ITA)

POOL D

	RAFIKOV Fazliddin	UZB	13	RAFIKOV F. (UZB)
	BALOGH Janos	HUN	14	BALOGH J. (HUN)
	KOVINIC Stefan	MNE	15	KOVINIC S. (MNE)
	KADZAEV Rustem	IJF	16	KADZAEV R. (IJF)

REPECHAGE

	PLOSCEANU C. (ROU)	29	PLOSCEANU C. (ROU)	100 s0/ 000 s0 [00:01]	33	NIKITENKO N. (GER)	000 s0/ 100 s0 [02:42]
	MESSE A-BESSONG J. (CAN)		NIKITENKO N. (GER)				
	BOROJEVIC M. (SRB)	30	BOROJEVIC M. (SRB)		34	BOROJEVIC M. (SRB)	101 s0/ 000 s0 [02:34]
	TUGUI D. (ROU)		TUGUI D. (ROU)				
	IAGAFAROV K. (IJF)	31	IAGAFAROV K. (IJF)		35	IAGAFAROV K. (IJF)	100 s0/ 000 s0 [02:07]
	KOSTANJSEK Z. (SLO)		KOSTANJSEK Z. (SLO)				
	BALOGH J. (HUN)	32	BALOGH J. (HUN)		40	BALOGH J. (HUN)	110 s0/ 000 s0 [02:26]
	KADZAEV R. (IJF)		KADZAEV R. (IJF)		36	BALOGH J. (HUN)	100 s0/ 000 s0 [00:21]

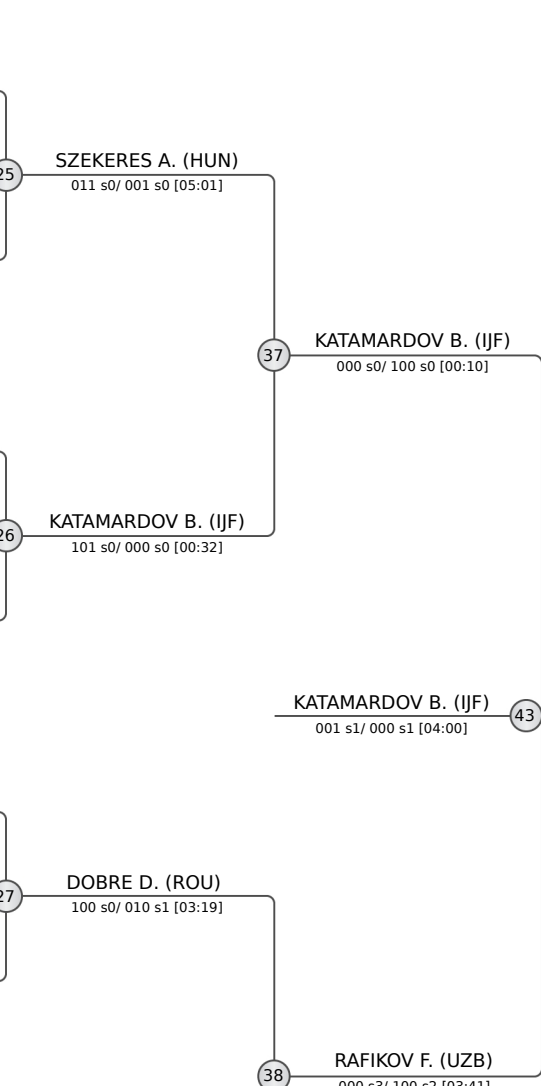

FINAL RESULTS

- KATAMARDOV Bislan (IJF)
- RAFIKOV Fazliddin (UZB)
- DOBRE Darius (ROU)
- IAGAFAROV Karim (IJF)
- NIKITENKO Nikita (GER)
- SZEKERES Abel (HUN)
- BOROJEVIC Mateja (SRB)
- BALOGH Janos (HUN)