

Tableau Général

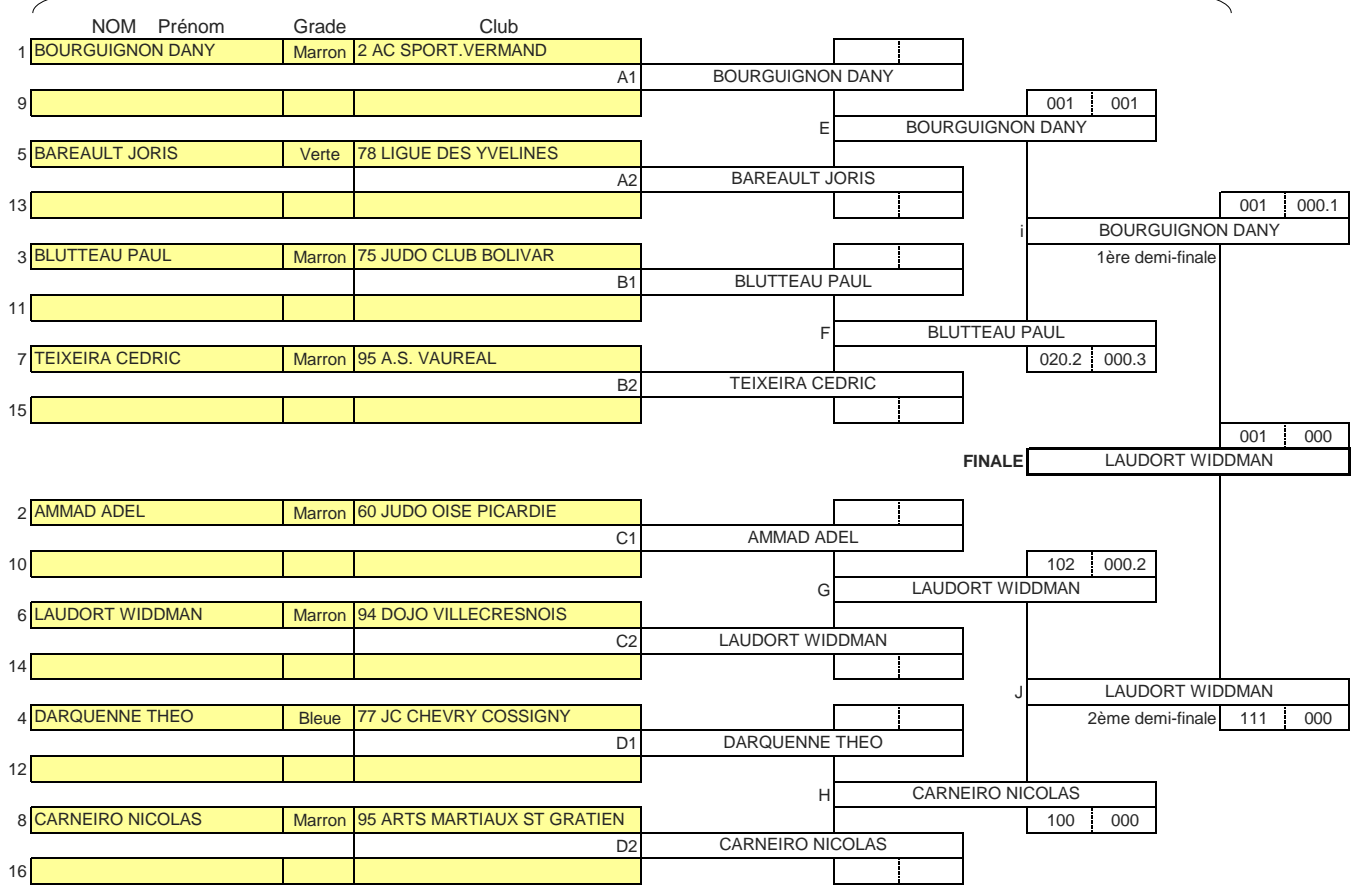

RESULTATS		
	NOM Prénom	CLUB
1°	LAUDORT WIDDMAN	94 DOJO VILLECRESNOIS
2°	BOURGUIGNON DANY	2 AC SPORT.VERMAND
3°	CARNEIRO NICOLAS	95 ARTS MARTIAUX ST GRATIEN
3°	AMMAD ADEL	60 JUDO OISE PICARDIE
5°	TEIXEIRA CEDRIC	95 A.S. VAUREAL
5°	BLUTTEAU PAUL	75 JUDO CLUB BOLIVAR

Repêchages Haut du Tableau

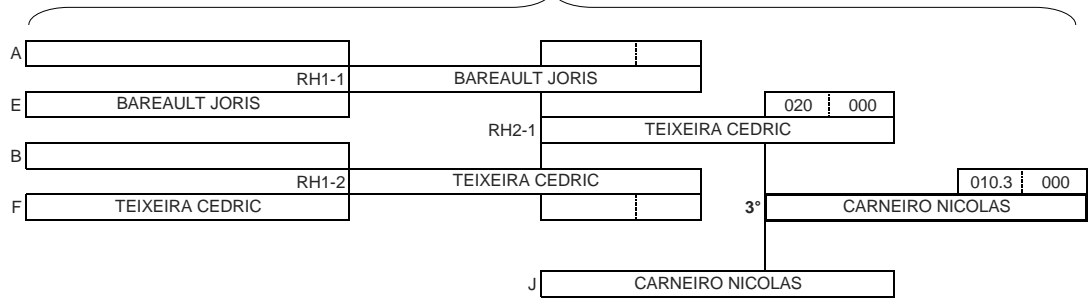

Repêchages Bas du Tableau



TABLEAU A



TABLEAU B

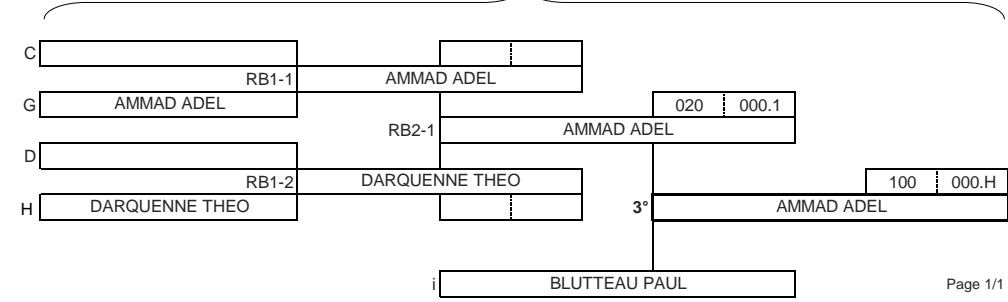

RESULTATS	
NOM Prénom	CLUB
1°	SORGIATI VINCENT 91 ALLIANCE JUDO BALLANCOUF
2°	MELIK CHAMSEDDINE 95 ARTS MARTIAUX ST GRATIEN
3°	MASURASHVILI VAKHTANG 76 J.C.GRD QUEVILLY
3°	ROMET VALENTIN 95 BUDOKAN DEUIL
5°	KADA ZAKARIYA 93 ST DENIS UNION SPORTS
5°	HADDOUCHE RAYAN 75 JUDO CLUB BOLIVAR

Repêchages Tableau A

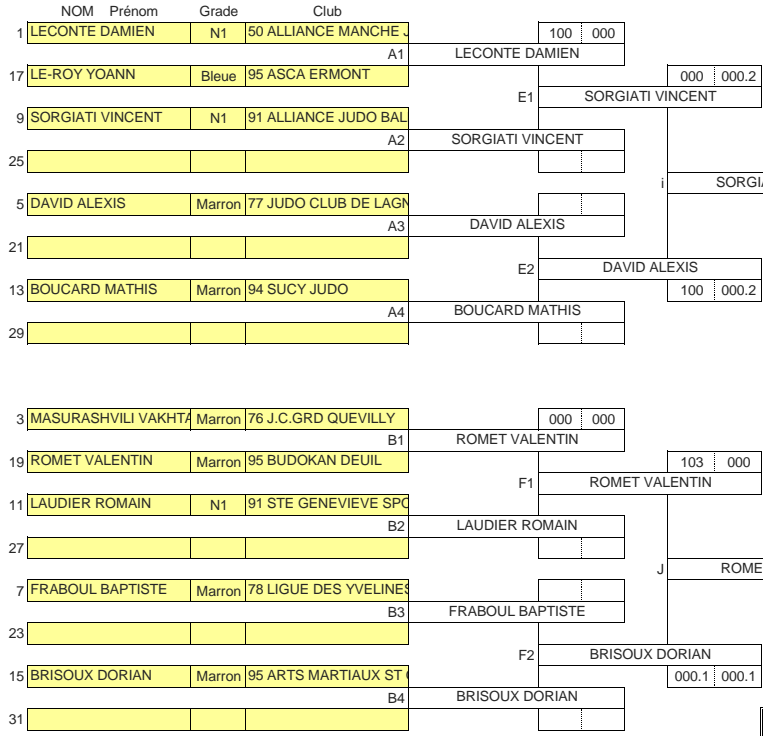
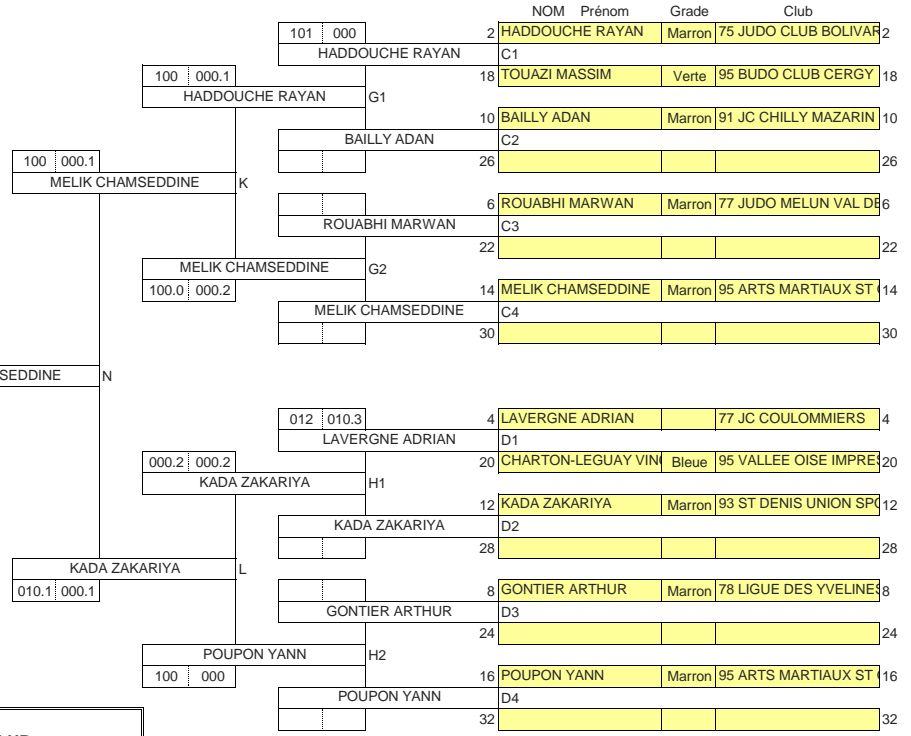
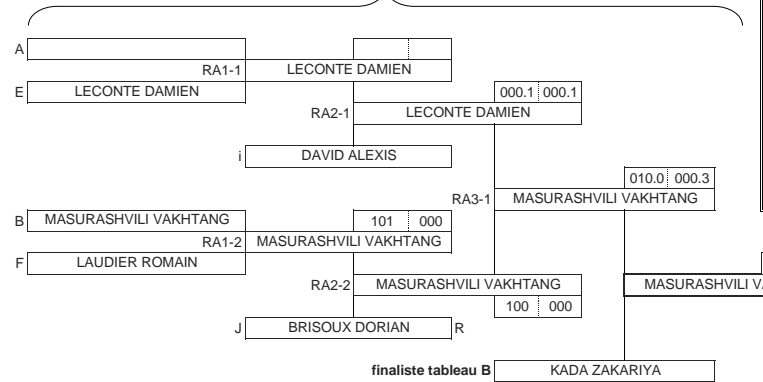

Repêchages Tableau B



TABLEAU A	TABLEAU B
------------------	------------------



RESULTATS		
	NOM Prénom	CLUB
1°	FERREIRA MICKAEL	95 ARTS MARTIAUX ST GRATIEN
2°	EDMOND ALEXANDRE	45 US.ORLEANS LOIRET JUDO J
3°	GUILLARD DANIEL	50 ALLIANCE MANCHE JUDO
3°	BAKHTIDZE GAGA	76 J.C.GRD QUEVILLY
5°	APPERT-COLLIN JEAN	91 STE GENEVIEVE SPORTS
5°	PAUL DYLAN	60 ALLONNE KODOKAN CLUB

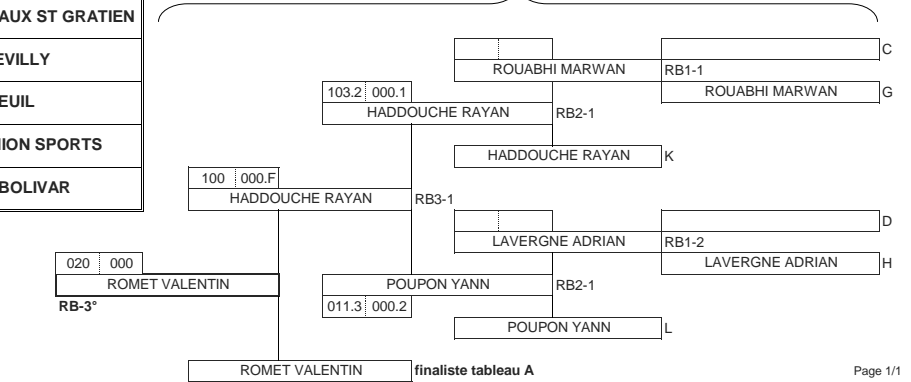
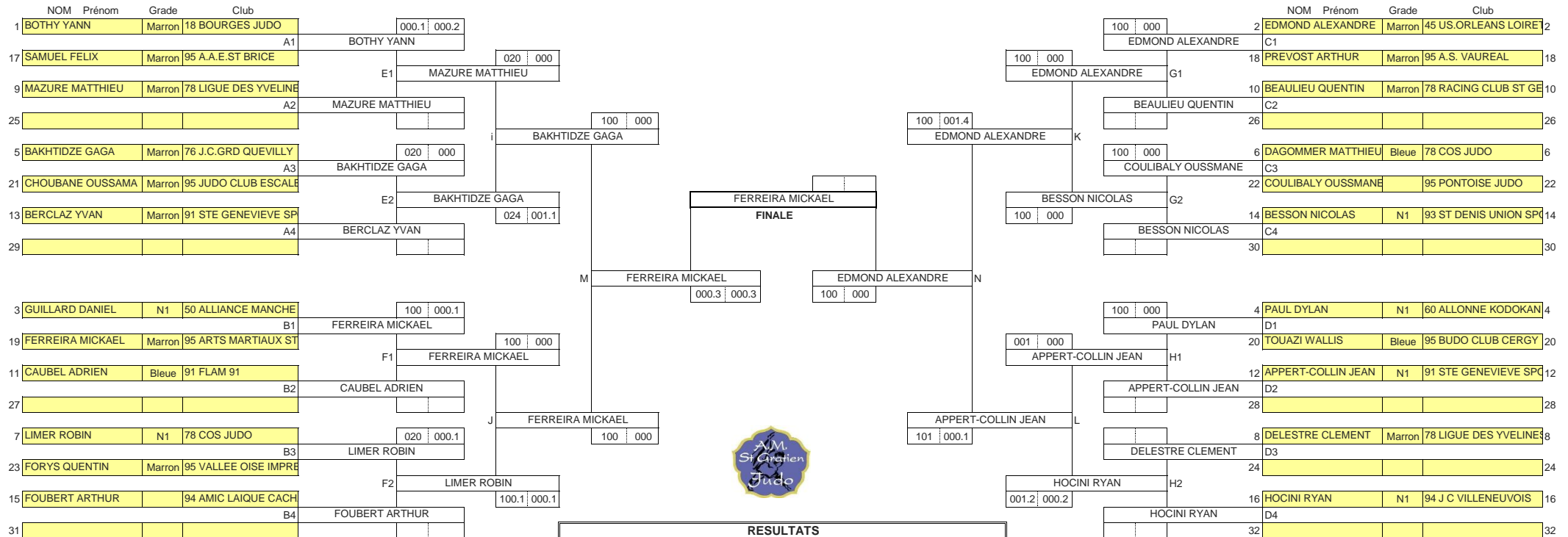

TABLEAU A

TABLEAU B

NOM	Prénom	Grade	Club		
1	CAFE CORENTIN	Marron	18 BOURGES JUDO	100	000
17	BILLON-FLOCH-LAY QU	Verte	78 M.J.C. CONFLANS ST	100	000
9	MAHFOUFI NASSIM		75 JUDO CLUB BOLIVAR		
25	BONTEMPS JASON	Verte	95 A.A.E.ST BRICE	020.2	000.1
5	BASSEZ RAPHAEL	Marron	60 FJEP C L CHAMBLY	101	000
21	BOURABA ANTHONY	N1	93 ST DENIS UNION SP		
13	BIFFOT NICOLAS	Marron	77 JUDO MELUN VAL DE	002.1	000.2
29	SIMON CHARLES	Bleue	95 ARTS MARTIAUX ST	111	000
3	TIHAY MAXIME	N1	45 US.ORLEANS LOIRE	101.1	000
19	N-TAMACK FABRICE		91 FLAM 91	021	000
11	GAZASHVILI SHALVA	Marron	76 J.C.GRD QUEVILLY		
27	GANGLOFF JEROME	Marron	95 A.M DE ST LEU LA F	100	000
7	LOPES-SANCHES BRAN	Marron	75 A.G.A.M.	100	000
23	ABABSA LAZHAR	Verte	94 AMIC LAIQUE CACHA		
15	RODRIGUES LEO		78 AAP LE GANT D OR	021	000
31	LARRIEU MATTHIEU		95 VALLEE OISE IMPRE	100	000

NOM	Prénom	Grade	Club		
2	MANDON LOIC	Marron	18 BOURGES JUDO	001.1	000
18	RAMIREZ GABRIEL	N1	91 FLAM 91	100	001
10	SIMON MACEO	Bleue	75 JUDO CLUB SORBIE		
26	ANE THIBAUT	Marron	95 A.M DE ST LEU LA F	111	011
6	QUILGHINI YANN	N1	60 FJEP C L CHAMBLY	021	001
22	BERNARDINI NICOLAS	Marron	93 US MULT.SECT. AUD		
14	ROUABHI DYLEM	N1	77 JUDO MELUN VAL DE	100	000
30	BARSEYNI DAMIEN	Marron	95 DOJO SANNOISIE	101	000
4	MONNEY QUENTIN	Marron	45 US.ORLEANS LOIRE	020	000
20	GRETT PHILIPPE	N1	91 J.C.SOISY/SEINE	100	000
12	GRIGALACHVILI TATO	Marron	76 J.C.GRD QUEVILLY		
28	HUI VALENTIN	N1	95 ARTS MARTIAUX ST	100	000
8	BURY DYLAN		75 JUDO CLUB BOLIVAR	110	000
24	GOMES BENJAMIN	Marron	94 RED STAR CHAMPIG		
16	BOUAMIRA MOHAMED-I	Marron	78 ASM MANTES LA JO	112	001
32					

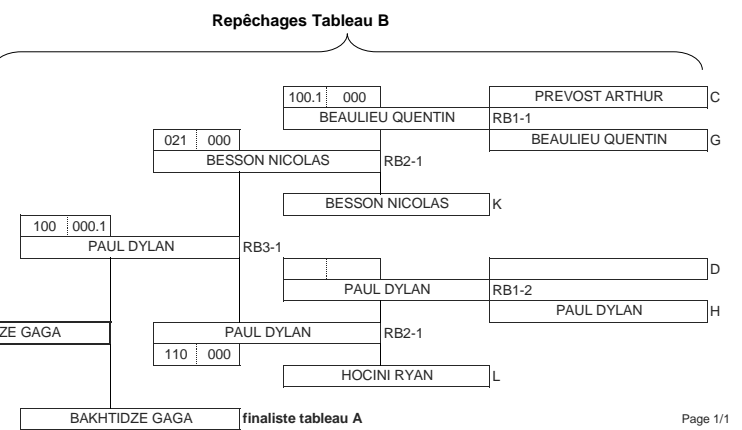
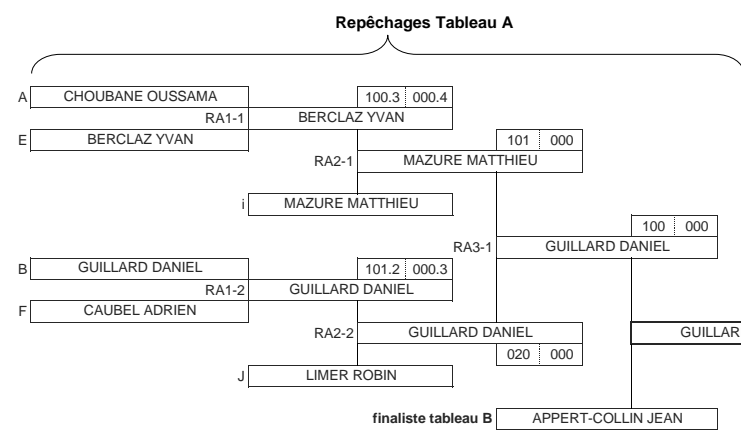

RESULTATS		
NOM Prénom	CLUB	
1°	GRIGALACHVILI TATO	76 J.C.GRD QUEVILLY
2°	GAZASHVILI SHALVA	76 J.C.GRD QUEVILLY
3°	BERNARDINI NICOLAS	93 US MULT.SECT. AUDONIENNE
3°	GOMES BENJAMIN	94 RED STAR CHAMPIGNY
5°	CAFE CORENTIN	18 BOURGES JUDO
5°	BIFFOT NICOLAS	77 JUDO MELUN VAL DE SEINE

Repêchages Tableau A

Repêchages Tableau B

A	SIMON CHARLES	RA1-1	BOURABA ANTHONY	b	102	001
E	BOURABA ANTHONY		CAFE CORENTIN		110	000
		RA2-1	CAFE CORENTIN	i		
			CAFE CORENTIN		100	000
		RA3-1	CAFE CORENTIN			
B	GANGLOFF JEROME	RA1-2	TIHAY MAXIME		100	000
F	TIHAY MAXIME		TIHAY MAXIME		100	000
		RA2-2	TIHAY MAXIME			
			BERNARDINI NICOLAS		020	000.1
		RA3-2	BERNARDINI NICOLAS	R		
			ABABSA LAZHAR		100	000
		J	ABABSA LAZHAR			
			BERNARDINI NICOLAS		100	000

			QUILGHINI YANN	C	001	000
			ROUABHI DYLEM	RB1-1		
			ROUABHI DYLEM		020	000
			ANE THIBAUT	K		
			GOMES BENJAMIN	RB3-1	001	000
			HUI VALENTIN	D	001.1	000
			HUI VALENTIN	RB1-2		
			MONNEY QUENTIN	H		
			GOMES BENJAMIN	RB2-1	100	000.1
			GOMES BENJAMIN		011	000.2
			GOMES BENJAMIN	L		

finaliste tableau B

finaliste tableau A

Tableau A Gauche



TABLEAU A

MOUSSA MOHAMED-LAMINE
0101 | 0000
FINALE TABLEAU A

TALBI ENZO
103 | 001

MOUSSA MOHAMED-LAMINE
100 | 001

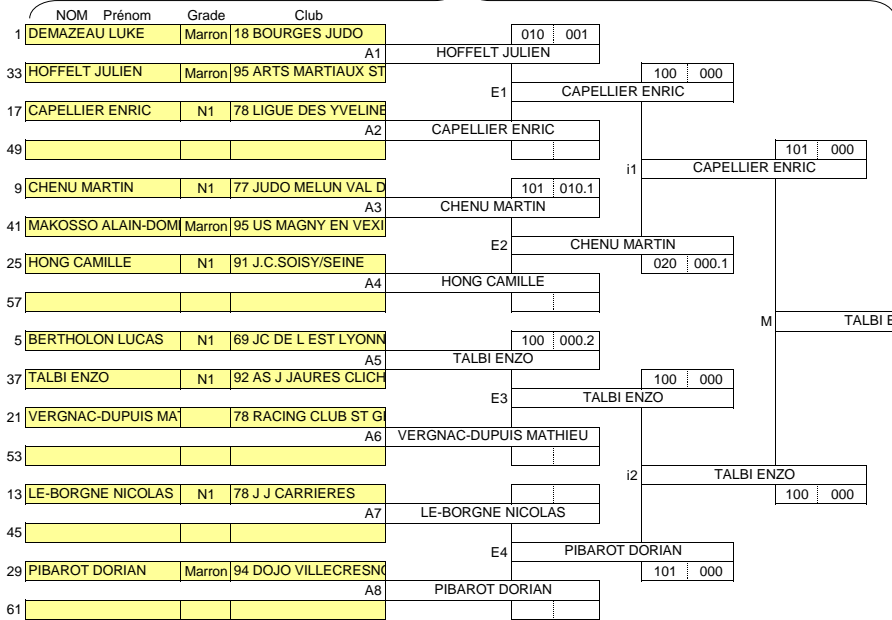
Tableau A Droite

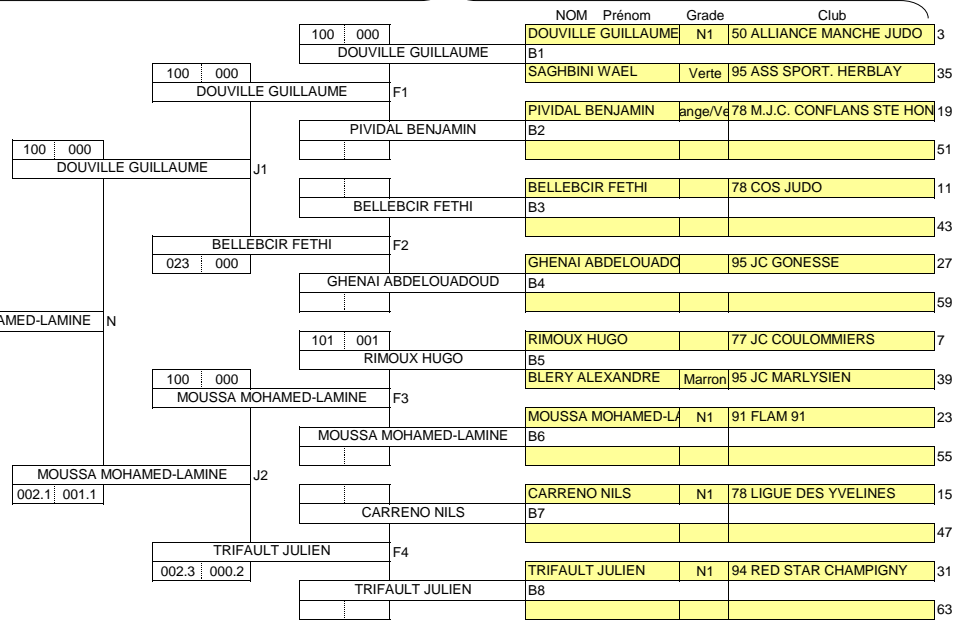



Tableau des Repêchages du Tableau B Gauche



Tableau des Repêchages du Tableau B Droite

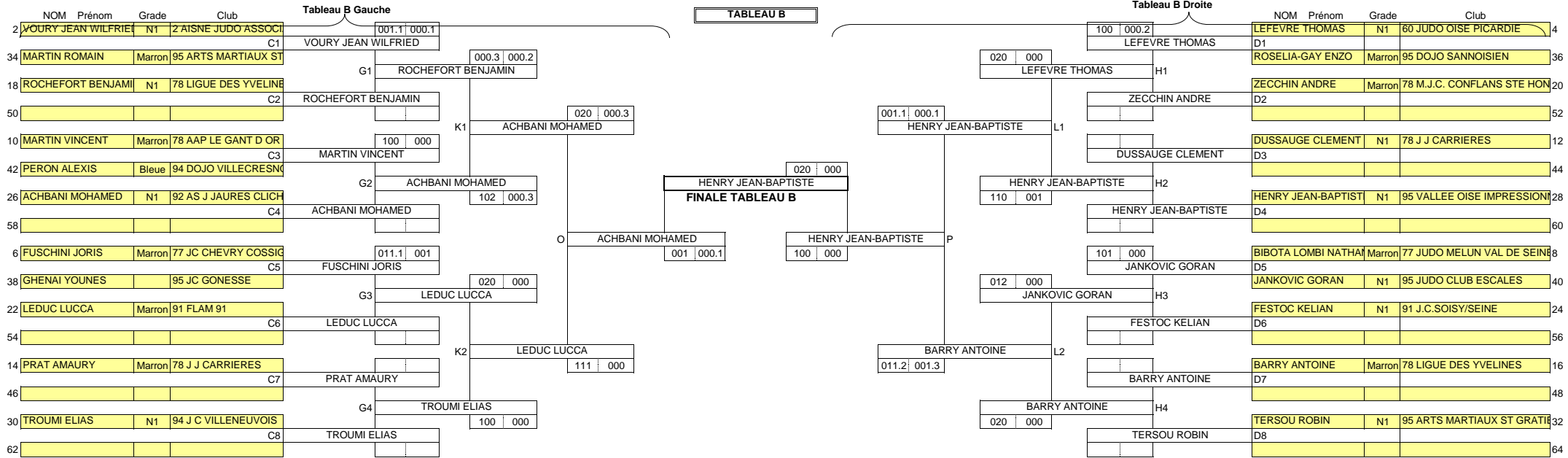

TALBI ENZO
FINALISTE TABLEAU A

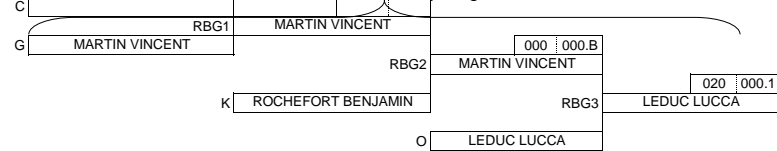
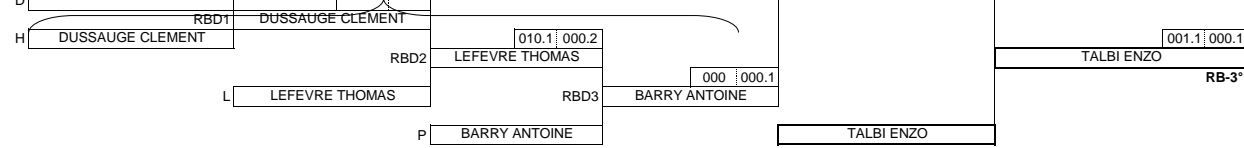

FINALE SUR LA FEUILLE DU TABLEAU A

TABLEAU A

TABLEAU B

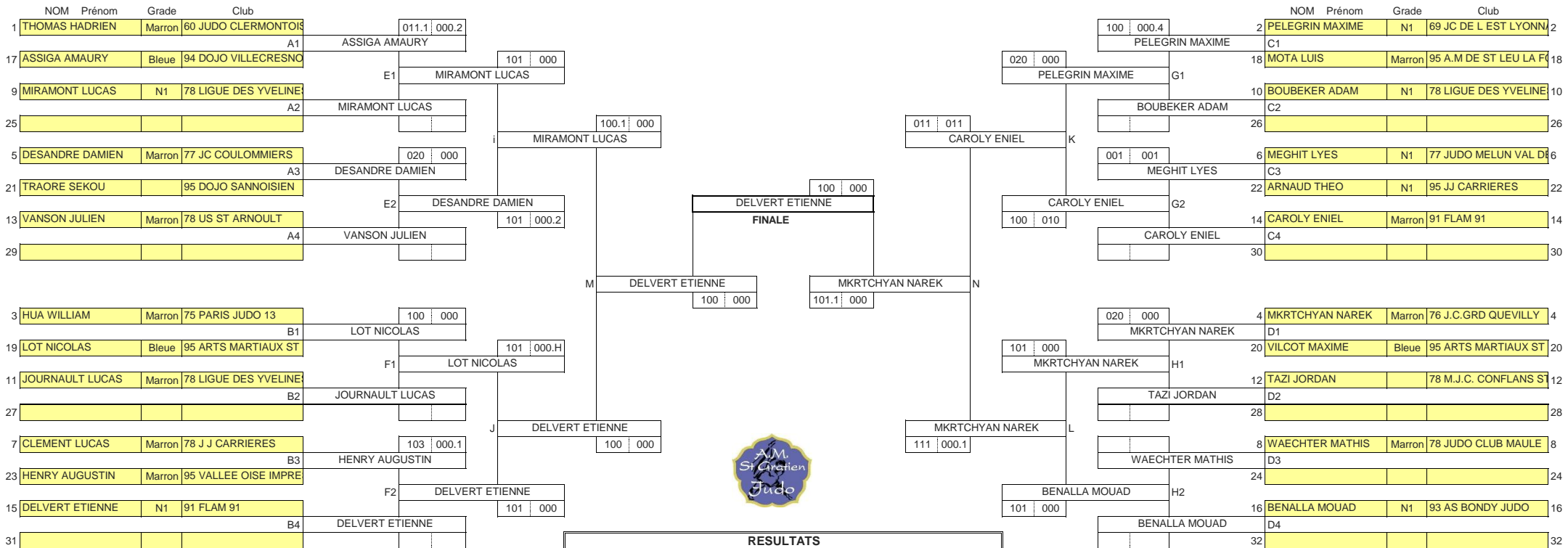

RESULTATS		
	NOM Prénom	CLUB
1°	DELVERT ETIENNE	91 FLAM 91
2°	MKRTCHYAN NAREK	76 J.C.GRD QUEVILLY
3°	HENRY AUGUSTIN	95 VALLEE OISE IMPRESSIONNISTES
3°	MEGHIT LYES	77 JUDO MELUN VAL DE SEINE
5°	CAROLY ENIEL	91 FLAM 91
5°	MIRAMONT LUCAS	78 LIGUE DES YVELINES

Repêchages Tableau A

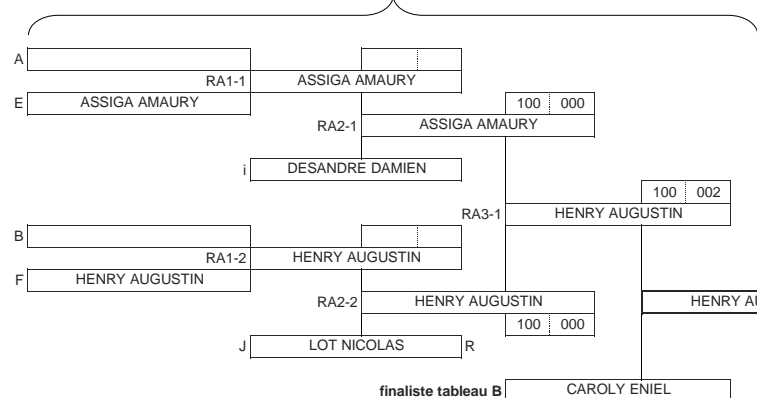

finaliste tableau B CAROLY ENIEL

Repêchages Tableau B

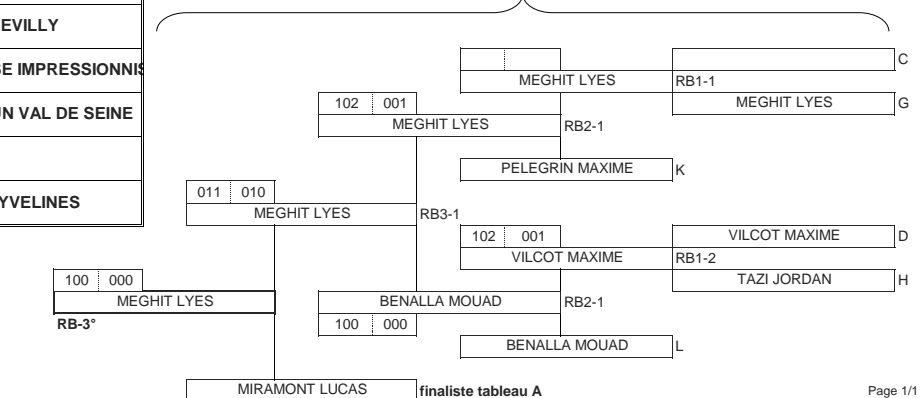

finaliste tableau A MIRAMONT LUCAS

Tableau Général

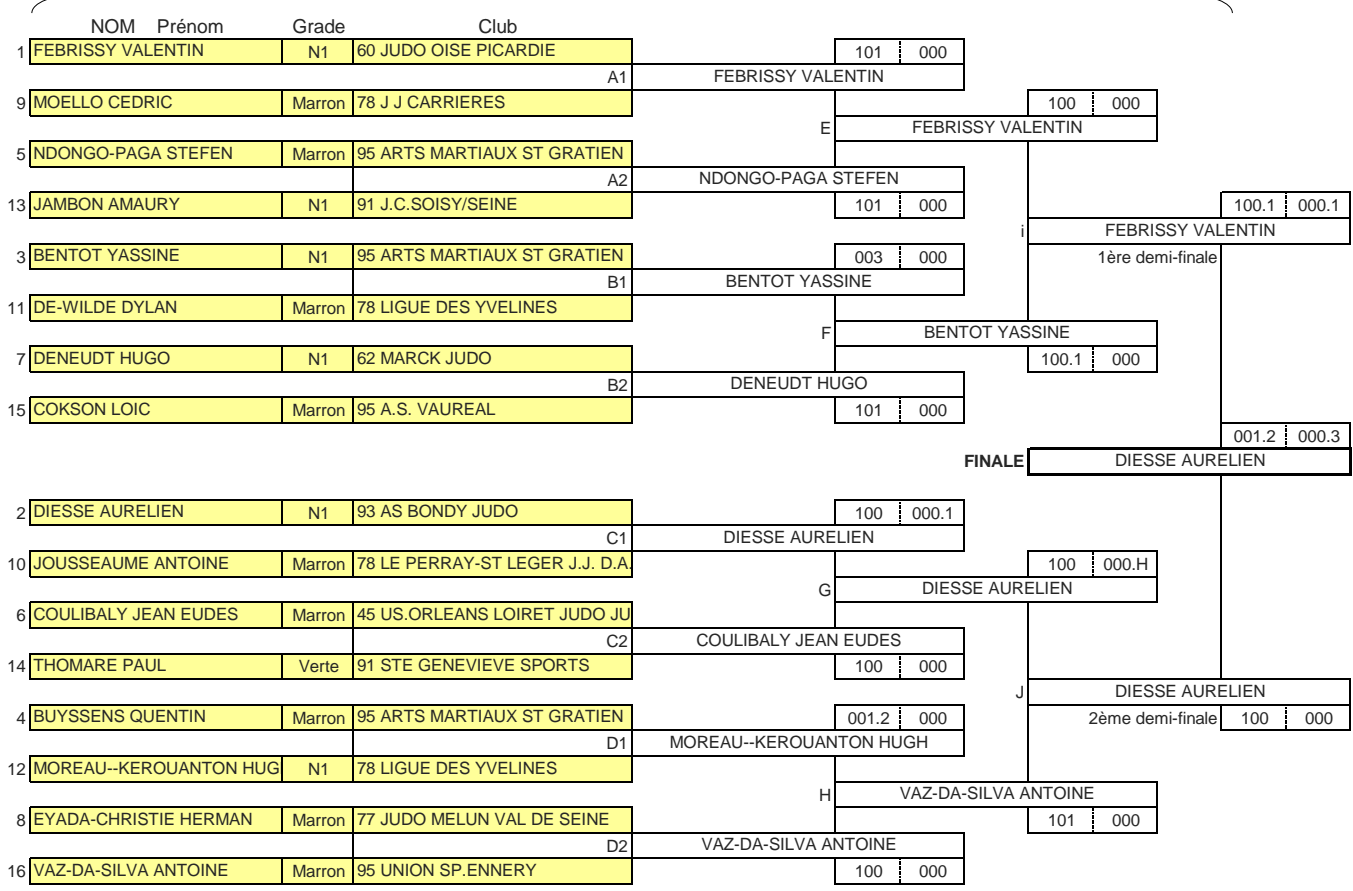

RESULTATS		
	NOM Prénom	CLUB
1°	DIESSE AURELIEN	93 AS BONDY JUDO
2°	FEBRISSY VALENTIN	60 JUDO OISE PICARDIE
3°	NDONGO-PAGA STEFEN	95 ARTS MARTIAUX ST GRATIEN
3°	MOREAU--KEROUANTON HUG	78 LIGUE DES YVELINES
5°	VAZ-DA-SILVA ANTOINE	95 UNION SP.ENNERY
5°	BENTOT YASSINE	95 ARTS MARTIAUX ST GRATIEN

Repêchages Haut du Tableau

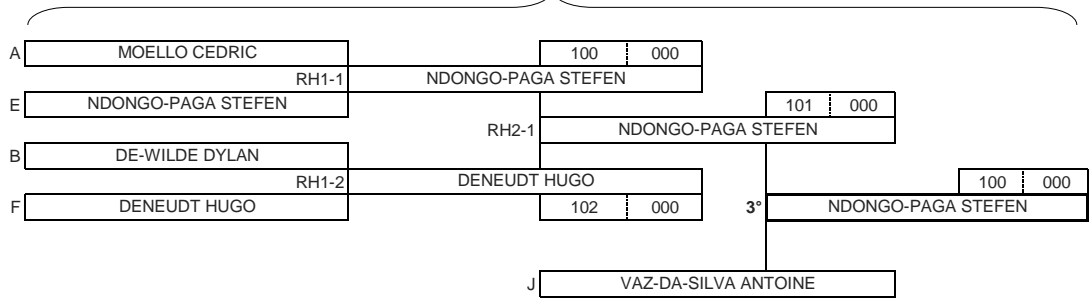

Repêchages Bas du Tableau



Tableau Général



RESULTATS		
NOM	Prénom	CLUB
1°	RABIER ALEXIS	91 FLAM 91
2°	CAROLY EVINTZ	91 FLAM 91
3°	LOUSSALA WILLIAM	93 ETOILE SP DE BLANC MESNIL JUD
3°	RAHALI SAMIR	95 JUDO CLUB ESCALES
5°	ABDALLA MAXIME	78 LIGUE DES YVELINES
5°	SINE SOFIAN	91 FLAM 91

Repêchages Haut du Tableau

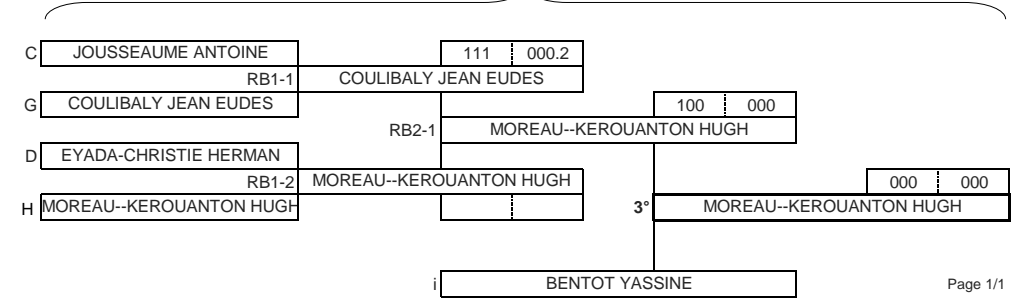
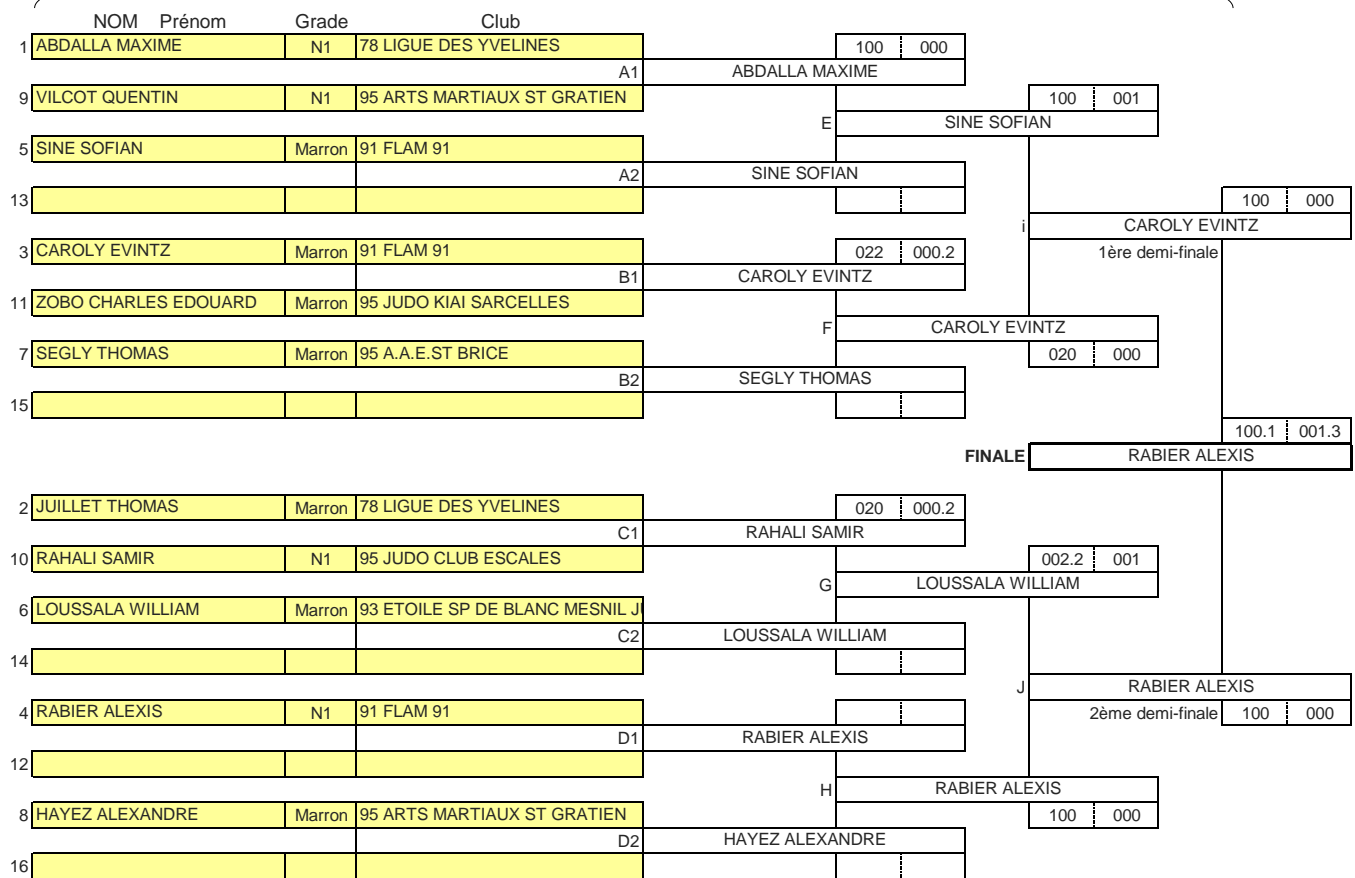
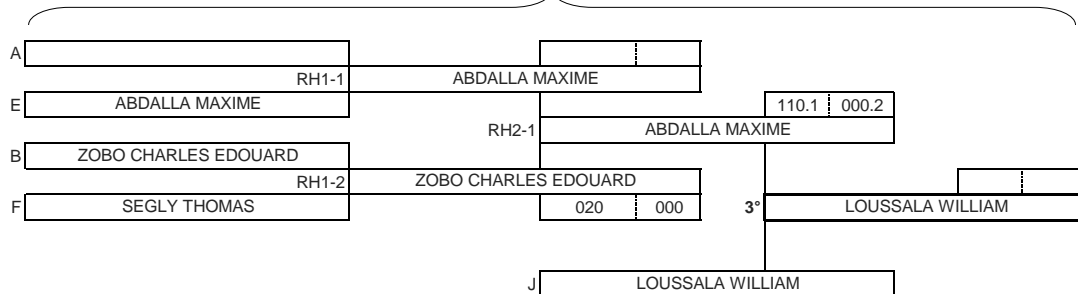

Repêchages Bas du Tableau

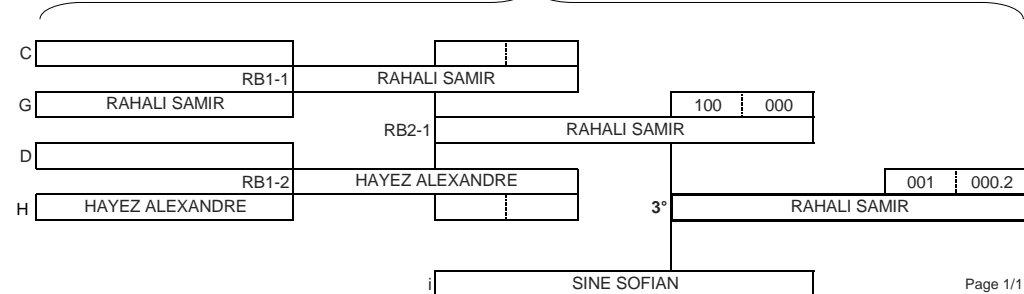

TOURNOI Michel BEAUVAIS

DATE : SAMEDI 05 AVRIL 2014

NB DE COMBATTANTS : 4

CATEG.

 CADETS
 MASCULINS
 + 90 kg

POULE DE 4 COMBATTANTS

TEMPS DES COMBATS : 4 MINUTES

 Poule n° : **1 sur 1**

Nom	Prénom	Club	COMBATS								Nombre de victoires	Nombre de points	Classement	
			rouge	1	3	Repos	1	2	Repos	1				2
			blanc	2	4		3	4		4				3
Grade														
MARC	ANTHONY	75 JUDO CLUB SORBIER	Marron	000			000			000		0	0	4 °
BRAS	LOIC	91 J.C.SOISY/SEINE	N1	100				000			100	2	20	2 °
BOUDJENANE	LOUNIS	93 JC RAINCY VILLEMOMBLE	Marron		000		000.1				001	1	1	3 °
KOMBO	JEAN GABRIEL	95 JUDO KIAI SARCELLES	Marron		101.1			111.2		100		3	30	1 °