

TOURNOI Michel BEAUVAIS	DATE : SAMEDI 05 AVRIL 2014	NB DE COMBATTANTS : 11	TEMPS DES COMBATS : 4 MINUTES	CATEG.	CADETTES FEMINIENS
	TABLEAU DE COMPETITION A DOUBLE REPECHAGE (POUR 16 COMBATTANTS)				- 48 kg

Tableau Général

	NOM	Prénom	Grade	Club			
1	GRAJWODA	CHLOE	Marron	45 US.ORLEANS LOIRET JUDO JU	100	000	
				A1	GRAJWODA CHLOE		
9	RENOT	MARINE	Marron	95 ARTS MARTIAUX ST GRATIEN	000.1	000.1	
				E	GRAJWODA CHLOE		
5	RECHIGNAT	AUDE	Marron	91 STE GENEVIEVE SPORTS			
				A2	RECHIGNAT AUDE		
13							102 010.1
							SAICHE LISA
3	KHATIR	INES	N1	8 US DES CHEMINOTS	100	000	
				B1	SAICHE LISA		
11	SAICHE	LISA	Marron	95 DOJO SANNOISIEN			
				F	SAICHE LISA		
7	BARBEY	CHARLOTTE	Marron	93 ETOILE SP DE BLANC MESNIL	101	000	
				B2	BARBEY CHARLOTTE		
15							110 000
							FINALE RECHIGNAT EVE
2	MAIRE	MARINE	Marron	78 LIGUE DES YVELINES	110	000	
				C1	BOUNETTA MELANY		
10	BOUNETTA	MELANY	Marron	95 ASS SPORT. HERBLAY	104	000.2	
				G	RECHIGNAT EVE		
6	RECHIGNAT	EVE	Marron	91 STE GENEVIEVE SPORTS			
				C2	RECHIGNAT EVE		
14							
							J RECHIGNAT EVE
4	COUURIER	LAURIE	N1	91 STE GENEVIEVE SPORTS			
				D1	COUURIER LAURIE		
12							
							H COUURIER LAURIE
8	DACOSTA	LAURY	Marron	94 JUDO CLUB FONTENAY	100	000	
				D2	DACOSTA LAURY		
16							



RESULTATS		
	NOM Prénom	CLUB
1°	RECHIGNAT EVE	91 STE GENEVIEVE SPORTS
2°	SAICHE LISA	95 DOJO SANNOISIEN
3°	KHATIR INES	8 US DES CHEMINOTS
3°	GRAJWODA CHLOE	45 US.ORLEANS LOIRET JUDO JUJITS
5°	COUURIER LAURIE	91 STE GENEVIEVE SPORTS
5°	BOUNETTA MELANY	95 ASS SPORT. HERBLAY

Repêchages Haut du Tableau

A	RENOT MARINE	100	000.1	
	RH1-1	RECHIGNAT AUDE		
E	RECHIGNAT AUDE	100.1	000	
	RH2-1	KHATIR INES		
B	KHATIR INES	100	000	
	RH1-2	KHATIR INES		
F	BARBEY CHARLOTTE	100	000	3°
				KHATIR INES
				J COUURIER LAURIE

Repêchages Bas du Tableau

C				
	RB1-1	BOUNETTA MELANY		
G	BOUNETTA MELANY	100	000	
	RB2-1	BOUNETTA MELANY		
D				
	RB1-2	DACOSTA LAURY		
H	DACOSTA LAURY	100	000	3°
				GRAJWODA CHLOE
				I GRAJWODA CHLOE

Tableau Général

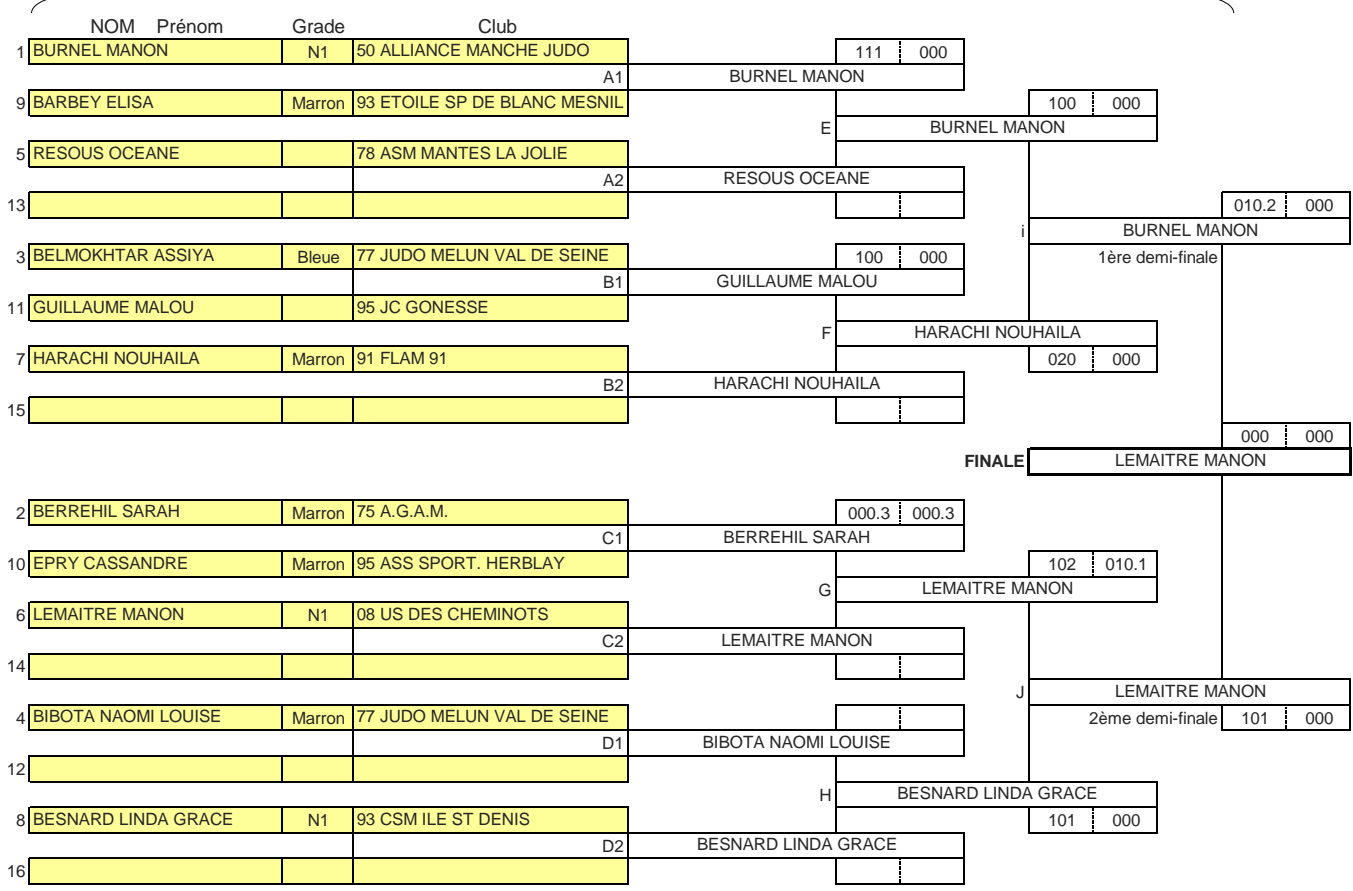

RESULTATS		
	NOM Prénom	CLUB
1°	LEMAITRE MANON	08 US DES CHEMINOTS
2°	BURNEL MANON	50 ALLIANCE MANCHE JUDO
3°	BESNARD LINDA GRACE	93 CSM ILE ST DENIS
3°	BERREHIL SARAH	75 A.G.A.M.
5°	BARBEY ELISA	93 ETOILE SP DE BLANC MESNIL JUD
5°	HARACHI NOUHAILA	91 FLAM 91

Repêchages Haut du Tableau

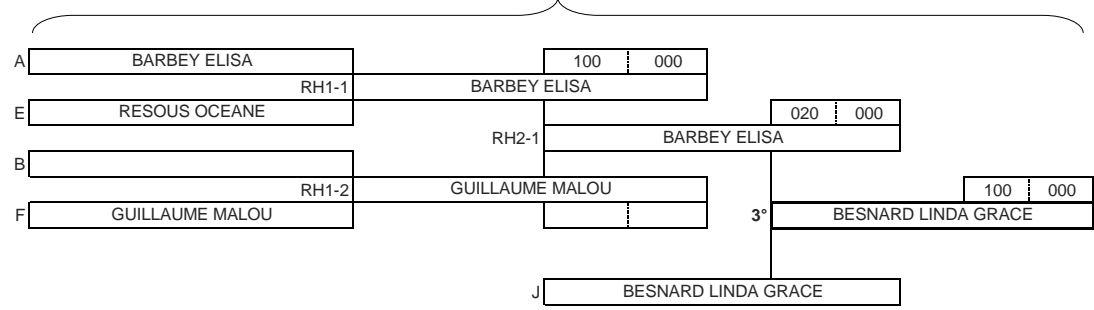

Repêchages Bas du Tableau

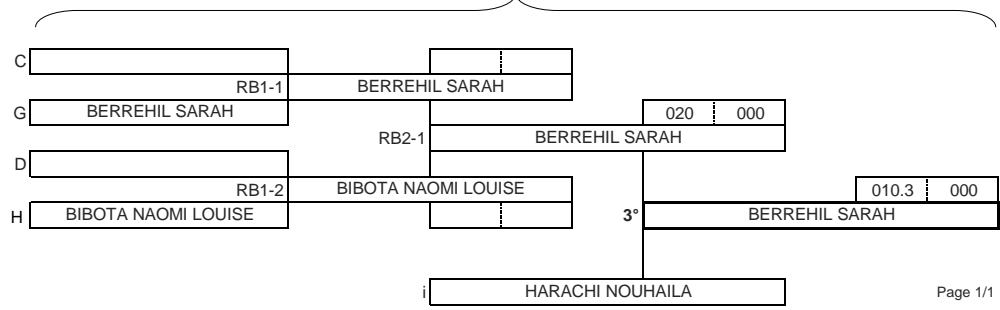

TABEAU DE COMPETITION A DOUBLE REPECHAGE (POUR 32 COMBATTANTS)

TABEAU A

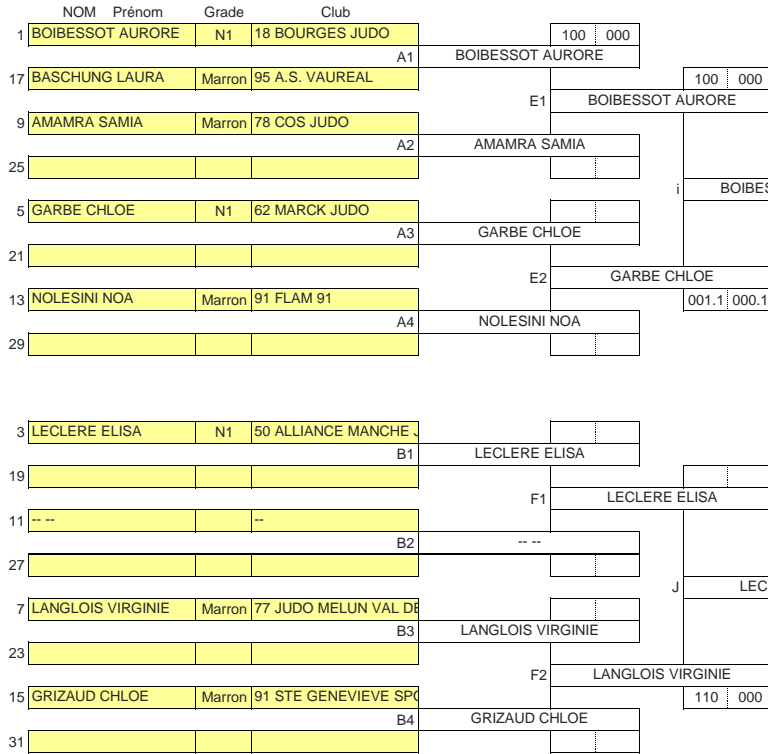

TABEAU B

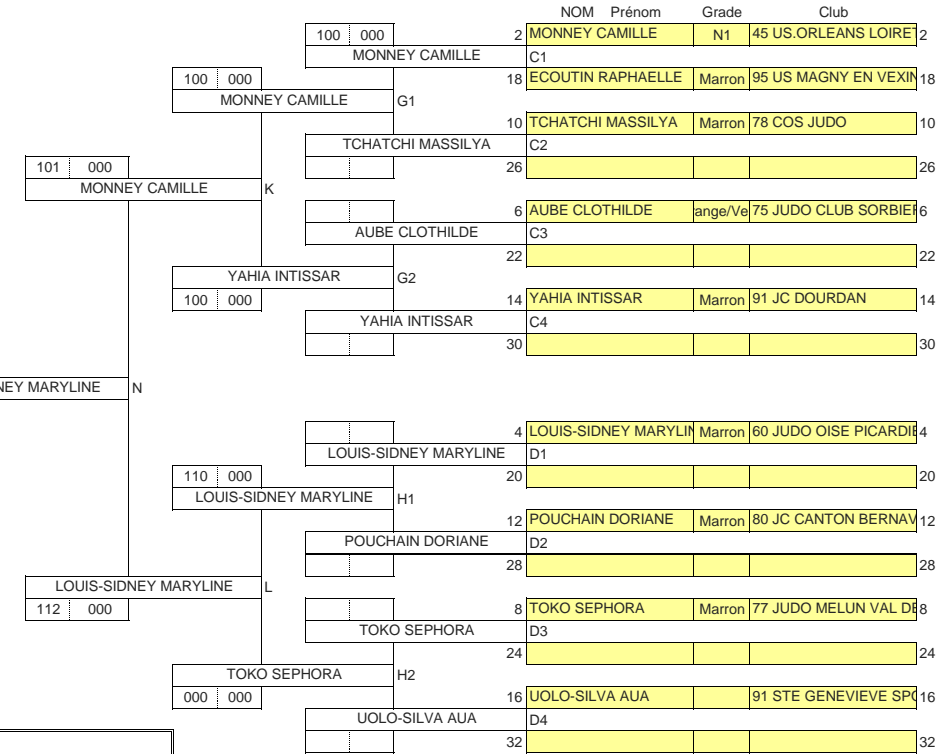

RESULTATS	
NOM Prénom	CLUB
1° LOUIS-SIDNEY MARYLINE	60 JUDO OISE PICARDIE
2° BOIBESSOT AUREORE	18 BOURGES JUDO
3° MONNEY CAMILLE	45 US.ORLEANS LOIRET JUDO JU
3° LECLERE ELISA	50 ALLIANCE MANCHE JUDO
5° GARBE CHLOE	62 MARCK JUDO
5° YAHIA INTISSAR	91 JC DOURDAN



Tableau Général



NOM Prénom		RESULTATS	CLUB
1°	VEGA ALEXIA		95 VALLEE OISE IMPRESSIONNISTES J
2°	MANIGA ELODIE		75 JUDO CLUB BOLIVAR
3°	BOUZZINE AHLAM		95 ARTS MARTIAUX ST GRATIEN
3°	KWANTEG GIFTY		78 ASM MANTES LA JOLIE
5°	LI SOPHIETOU		95 ARNOUVILLE JUDO FITNESS
5°	BERNARDINI CHARLOTTE		93 US MULT.SECT. AUDONNIENNE

Repêchages Haut du Tableau

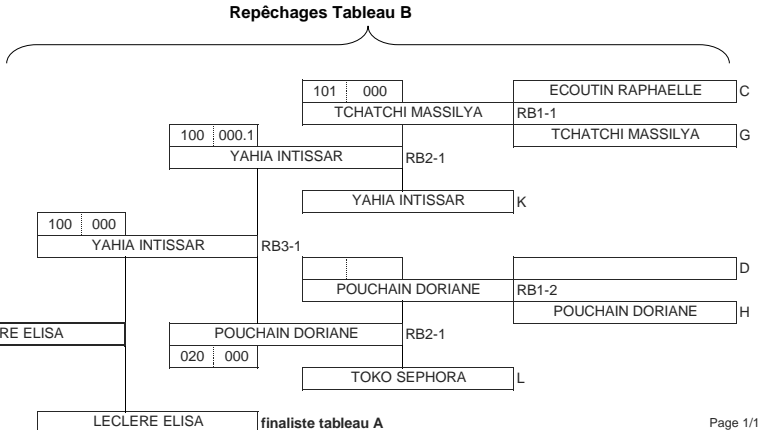
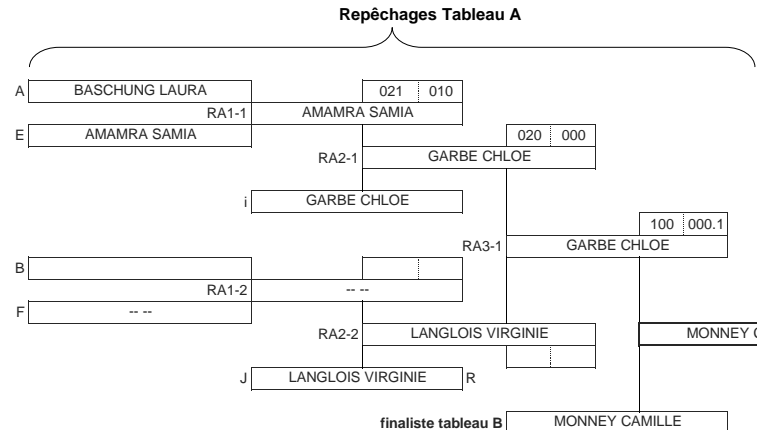
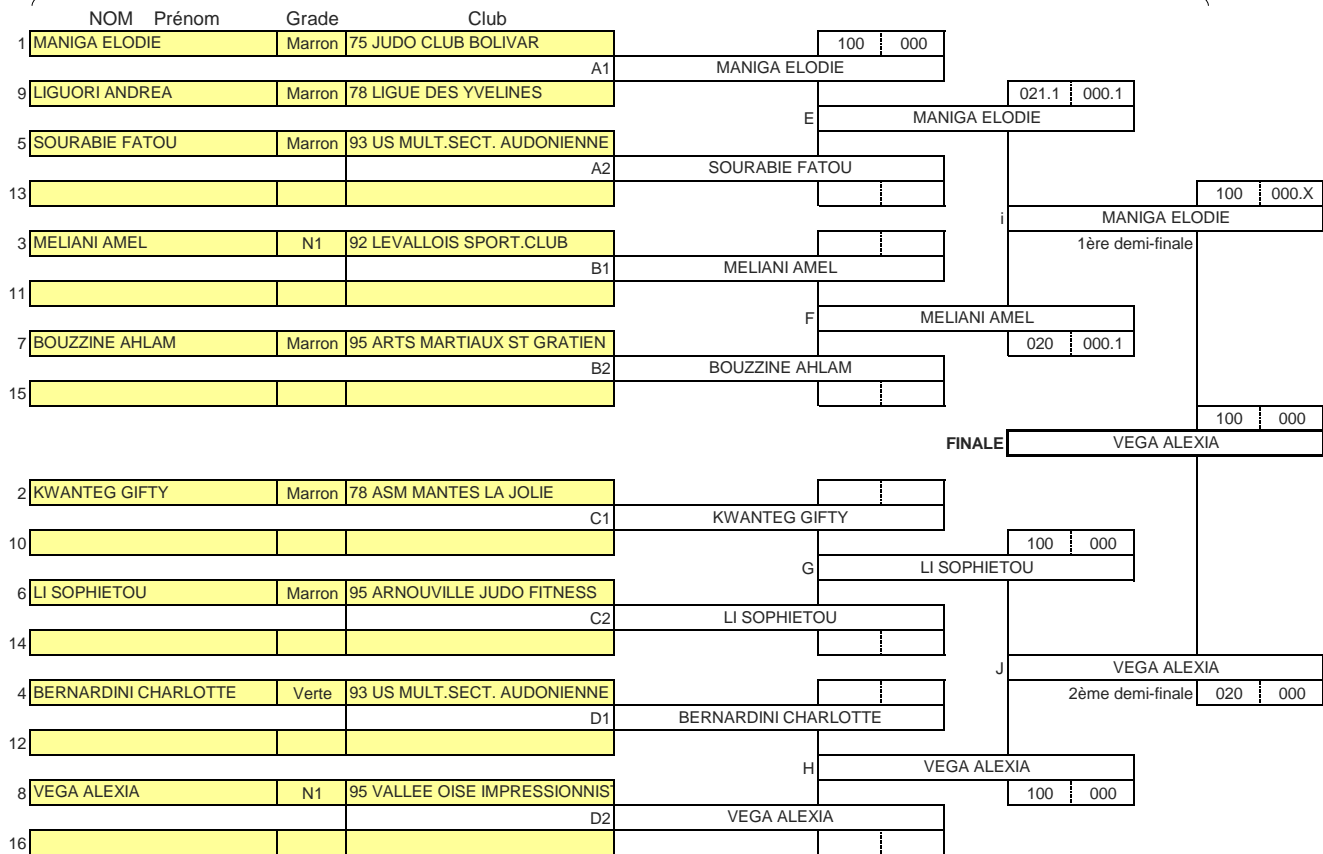
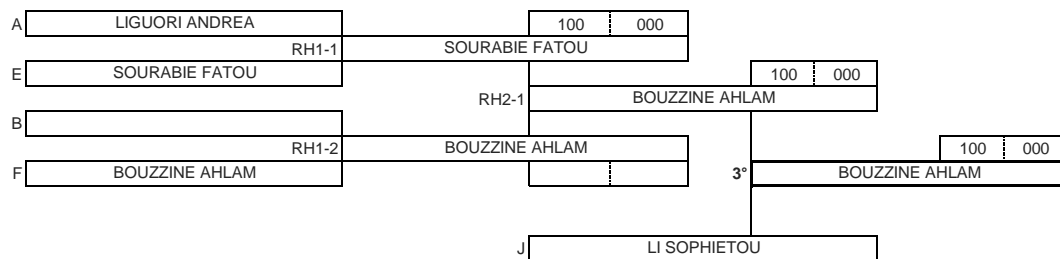

Repêchages Bas du Tableau



Tableau Général



RESULTATS		
	NOM Prénom	CLUB
1°	OUAMER ANAIS	78 LIGUE DES YVELINES
2°	KOZAK TATIANA	95 ARTS MARTIAUX ST GRATIEN
3°	VUILLEMENOT CHLOE	94 SMUS VGA ST MAUR
3°	DOMAIN BRITTANY	45 US.ORLEANS LOIRET JUDO JUJITS
5°	TSHIBANDA NTUMBA EDITH	78 LIGUE DES YVELINES
5°	BAUER LEOPOLDINE	78 LIGUE DES YVELINES

Repêchages Haut du Tableau

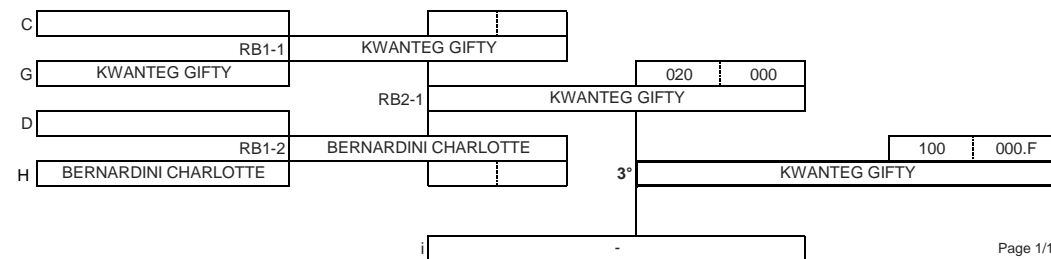
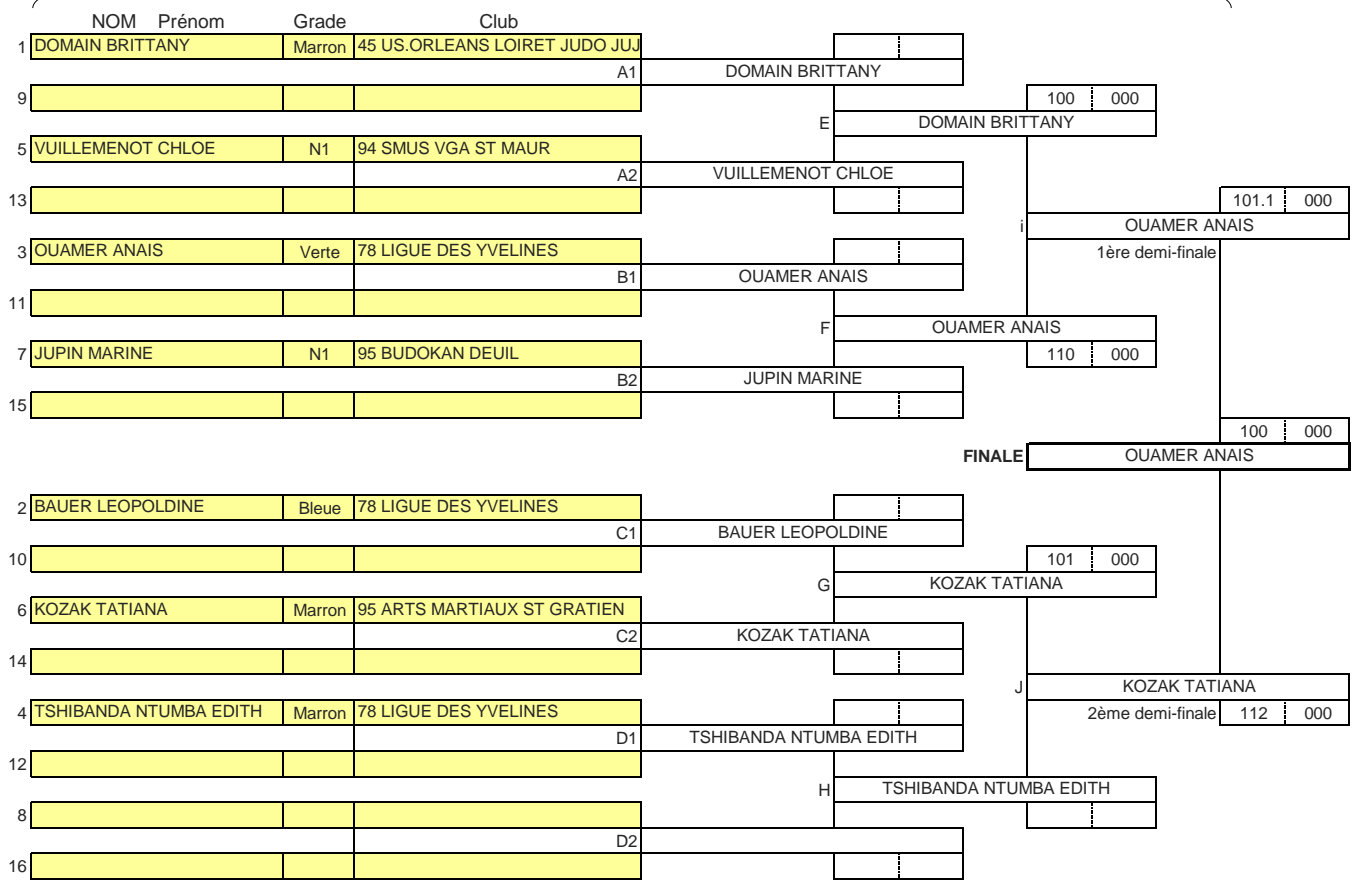
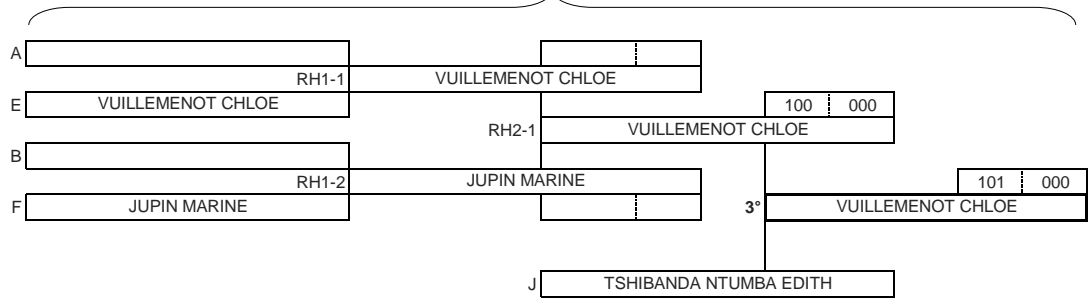

Repêchages Bas du Tableau



Tableau Général



RESULTATS		
	NOM Prénom	CLUB
1°	DERROUAZI SOUMAYA	78 LIGUE DES YVELINES
2°	MOUNE-HANACK-WINIE HONO	91 FLAM 91
3°	LEMONNIER CHLOE CHRISTE	50 ALLIANCE MANCHE JUDO
3°	VERNAUDON RAUHITI	91 STE GENEVIEVE SPORTS
5°	SEBASTIAO DORCAS	93 US MULT.SECT. AUDONNIENNE
5°	DAOUDI-IDRISSI DOUNIA	75 KODOKAN PARIS 15

Repêchages Haut du Tableau

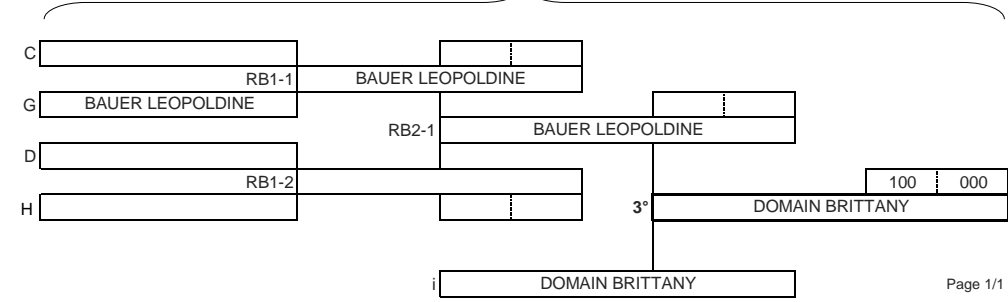
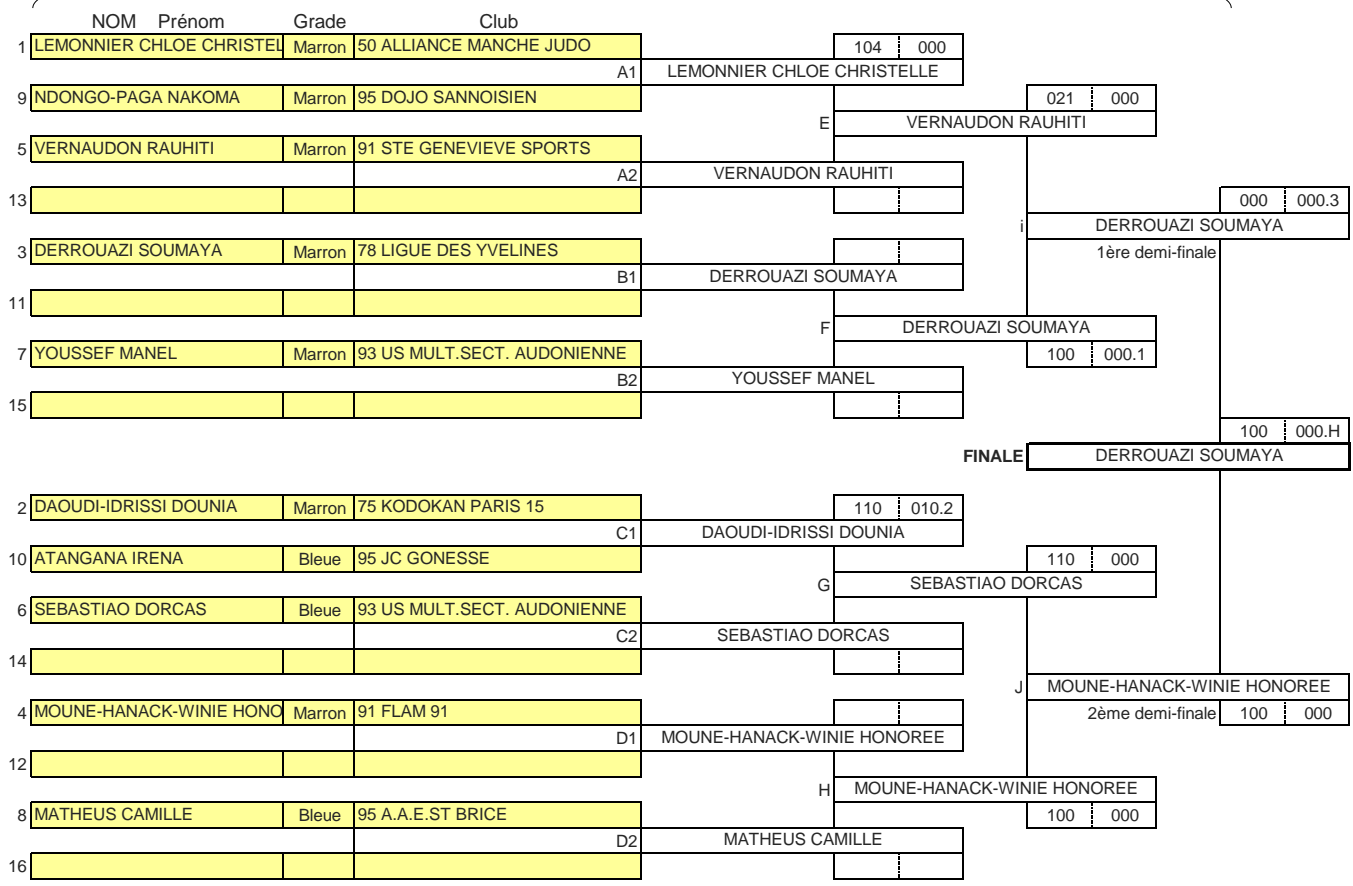
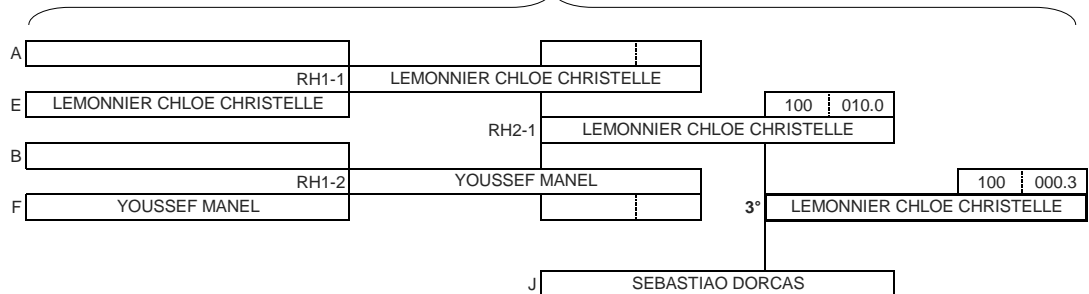

Repêchages Bas du Tableau

