

**RESULTATS 1/2 Finale France NORD-EST
JUNIORS MASCULINS
15 Mars 2009 - ST DIE DES VOSGES**



CAT	CLASSEMENT	NOM	CLUB	LIGUE	
-55					
	Q	1	LEBOEDEC Victor	J.C. BAR SUR AU	CHAMP
	Q	2	DE SALENEUVE Kenny	DOJO VOSGIEN	LORR
	Q	3	RAHMANI Mehdi	JCO 59 ROUBAIX	NPC
	Q	3	AGBOHOU Maxime	FRANCHE COMTE J	FC
	Q	5	DRIDI Ayoub	TOURCOING CTAM	NPC
	Q	6	PIAT Guillaume	JC AUDINCOURT	FC
		7	DENNERY David	J C DE BORNEL	PIC
		7	MERLEVEDE Julien	JC S.O. MARNAIS	CHAMP
Q HQN	B		BOULANGER Adrien	ACAMA	NPC
	Q	HQ	AGBOHOU Thibaud	FRANCHE COMTE J	FC
-60					
	Q	1	COSSEZ Quentin	CERCLE AUBOIS A	CHAMP
	Q	2	HERZOG Antoine	ACS PEUGEOT MUL	ALS
	Q	3	DAMASO Julien	MONTMIRAILLAIS	CHAMP
	Q	3	DELERUE Fabien	JC LA MADELEINE	NPC
	Q	5	MACKEREEL Julien	JUDO OISE PIC	PIC
R1		6	DEVILLERS Guillaume	J.C.SARREBOURG	LORR
		7	BENMOSTEFA Reda	JC GRENAYSIEN	NPC
		7	DE COL Anthony	JUDO OISE PIC	PIC
R3		9	THIEBAUD Jonathan	FRANCHE COMTE J	FC
	Q	HQ	JOSEPH Julien	AILLY SUR SOMME	PIC
-66					
	Q	1	BOUCHER Mathias	DOJO REMOIS	CHAMP
	Q	2	FEUILLAS Louis	J.C.DE STRASBOU	ALS
	Q	3	DIFURIA Sacha	J.C.SARREBOURG	LORR
	Q	3	VANACKER Thomas	JKC BOULOGNE	NPC
	Q	5	CLERGET Arthur	SPORTING MARNAV	CHAMP
	Q	6	SALLARD Geoffrey	VIEUX CONDE	NPC
		7	LANGLET Antoine	HARAGEI-LAVENTI	NPC
		7	GREULET Damien	J.C. BAR SUR AU	CHAMP
Q HQN	B		ELFAIZ Julien	JCB ARRAS	NPC
Q HQN	B		KUSTER Florian	A.J. 54	LORR
-73					
	Q	1	SERAICHE Mohamed	VIEUX CONDE	NPC
	Q	2	CLAUDEL Marcellin	J.C.ST DIE	LORR
	Q	3	COLLIN Benoit	JKC BOULOGNE	NPC
	Q	3	BRIOTET Florian	J.C.SARREBOURG	LORR
	Q	5	FATOU Ted	SMPS DUNKERQUE	NPC
	Q	6	LECLERCQ Baptiste	J.C.SARREBOURG	LORR
		7	FLAMANT Julien	SPORTING MARNAV	CHAMP
	Q	7	GALVEZ Justin	FRANCHE COMTE J	FC
-81					
	Q	1	HENRION Quentin	FRANCHE COMTE J	FC
	Q	2	THIEFFRY Thibaut	JC HEM	NPC
	Q	3	RAKOTONDRAMANITRA Ga	O.F.P.N.D.	LORR
	Q	3	MICHEL Remy	JUDO OISE PIC	PIC
	Q	5	SCHARFF Remi	J.C.SARREBOURG	LORR
	Q	6	KRUSKA Jordan	DOJO VOSGIEN	LORR
		7	LOZUPONE Patrice	AJMETZ	LORR
R4		7	FOUQUET Etienne	JKC BOULOGNE	NPC
-90					
	Q	1	BOUTROUILLE Gregoire	JKC BOULOGNE	NPC
	Q	2	AGNIMEL Pierre emman	J.C.DE STRASBOU	ALS
	Q	3	BARBET Francois	REIMS JUDO	CHAMP
	Q	3	ELKOSTITI Anass	HALLUIN	NPC
	Q	5	THELLIER Xavier	U.S.A.L. JUDO J	NPC
R2		6	HUL Jonathan	ASL PONTFAVEGER	CHAMP
		7	FRIQUET Bastien	AS DE VERRIERES	CHAMP
		7	VON HATTEN Thomas	JUDO CLUB VOSGE	ALS
Q HQN	B		SONNEY Arnaud	FRANCHE COMTE J	FC

<i>CAT</i>	<i>CLASSEMENT</i>	<i>NOM</i>	<i>CLUB</i>	<i>LIGUE</i>	
	Q	NC	CORE Alexis	JC OMOIS	PIC
-100	Q	1	KELLER Thomas	JUDO CLUB KAYSE	ALS
	Q	2	VENNAT Aymeric	JUDO OISE PIC	PIC
	Q	3	REGNER Arnaud	JC BULLYGEOIS	NPC
	Q	3	LENDERINK Michel	J.C.SARREBOURG	LORR
	Q	5	VERHEYE Geoffrey	ASPTT LILLE	NPC
RCAT		6	LAMRANI Yacine	JC EDMOND VOLLM	ALS
		7	MENUGE Andy	ELEU JUDO CLUB	NPC
		7	ABOUSSEMDAI Bilal	HELLEMMES	NPC
Q HQN		B	FALK Alexandre	J.C.QUATZENHEIM	ALS
+100	Q	1	BOUAFIA Macinissa	Alliance Judo59	NPC
	Q	2	MERRHEIM Aurelien	JC SOLESMOIS	NPC
	Q	3	MEYER Cedric	ACS PEUGEOT MUL	ALS
	Q	3	RUDI Alexandre	JC FLERS SART	NPC
	Q	5	COGNY Romain	INSTITUT LILLER	NPC
RCAT		6	MEYER Thiebaut	AM COLMAR	ALS
		7	GORSY Damien	JC KAYSERSBERG	ALS
		7	MORLA Mickael	J.C. CALAISIE	NPC
Q HQN		B	LOOS Quentin	JC MOLSHHEIM ENV	ALS
Q HQN		B	BLAISON Kevin	SMEC METZ JUDO	LORR

DEMI FINALE CHPT FRANCE JUNIORS

ST DIE DES VOSGES 15/03/2009-15/03/2009

Cat. -55

Nb. Judokas : 19

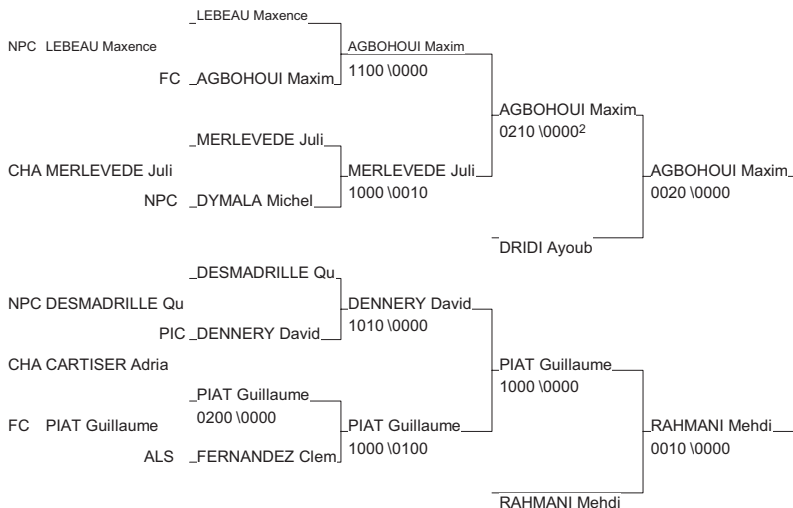
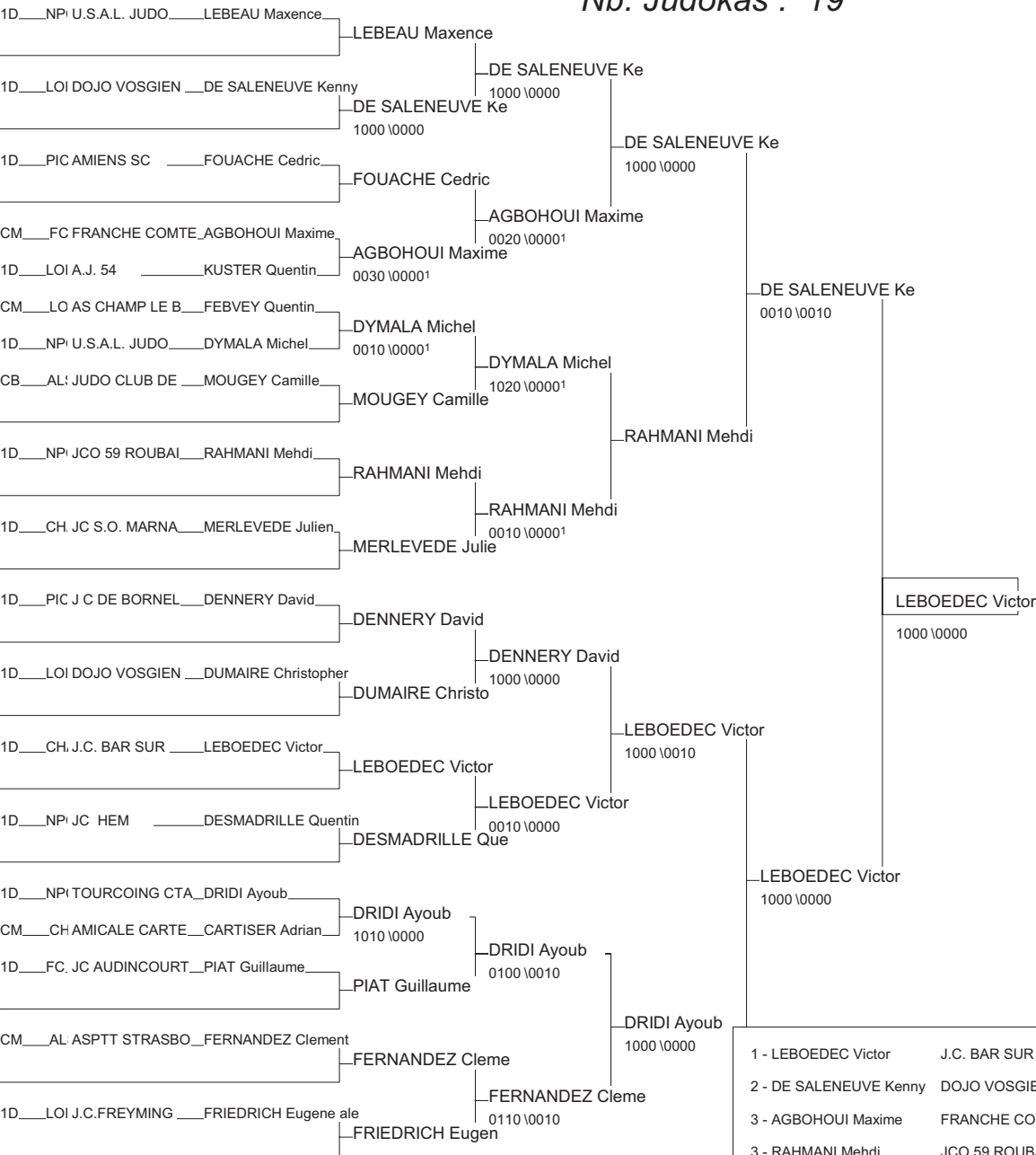

DEMI FINALE CHPT FRANCE JUNIORS

ST DIE DES VOSGES 15/03/2009-15/03/2009

Cat. -73

Nb. Judokas : 29

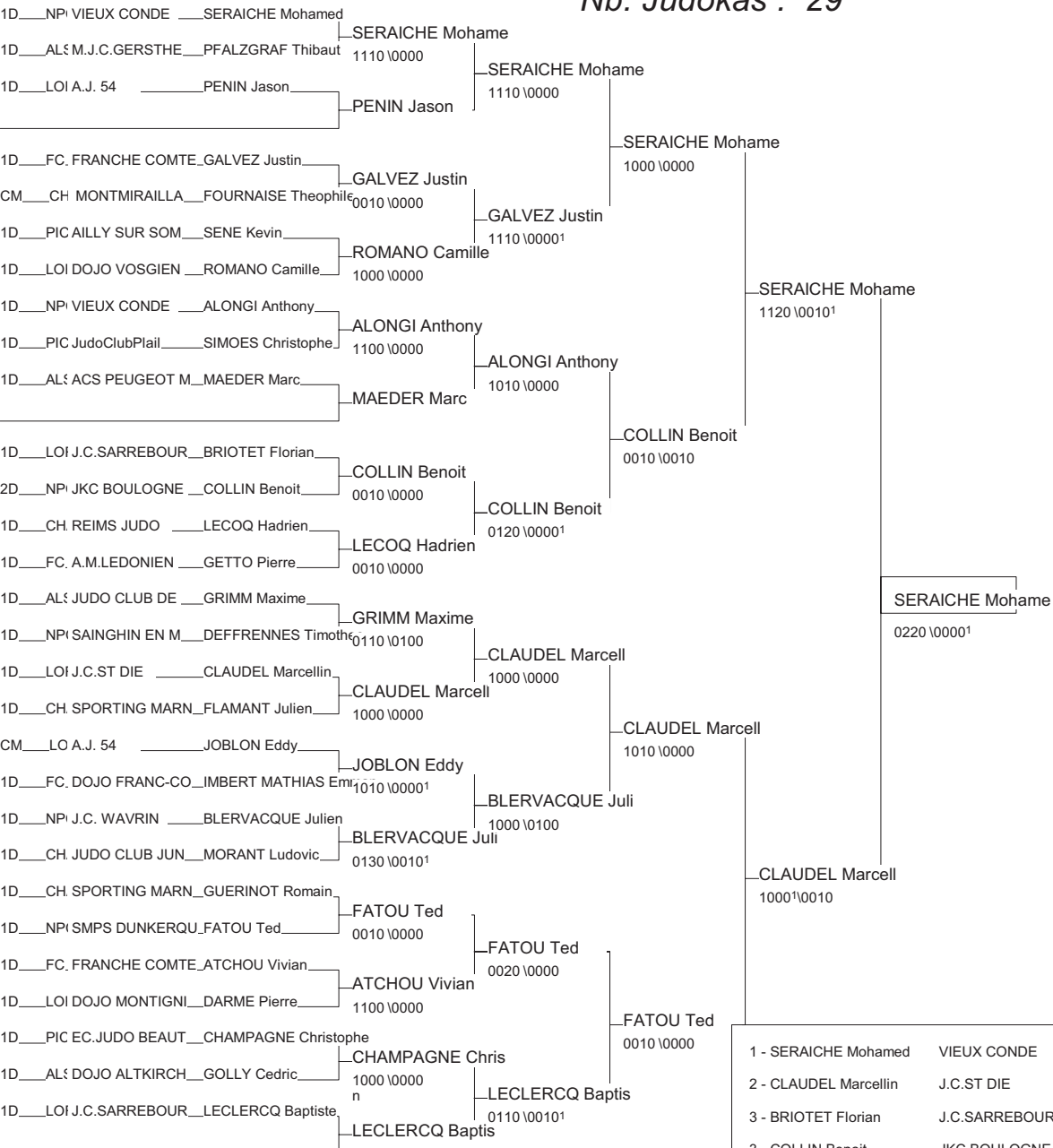

1 - SERAICHE Mohamed	VIEUX CONDE	NPC	NPC
2 - CLAUDEL Marcellin	J.C.ST DIE	LORR	LOR
3 - BRIOTET Florian	J.C.SARREBOURG	LORR	LOR
3 - COLLIN Benoit	JKC BOULOGNE	NPC	NPC
5 - FATOU Ted	SMPS DUNKERQUE	NPC	NPC
5 - LECLERCQ Baptiste	J.C.SARREBOURG	LORR	LOR
7 - GALVEZ Justin	FRANCHE COMTE	FC	FC
7 - FLAMANT Julien	SPORTING MARN	CHA	CHA

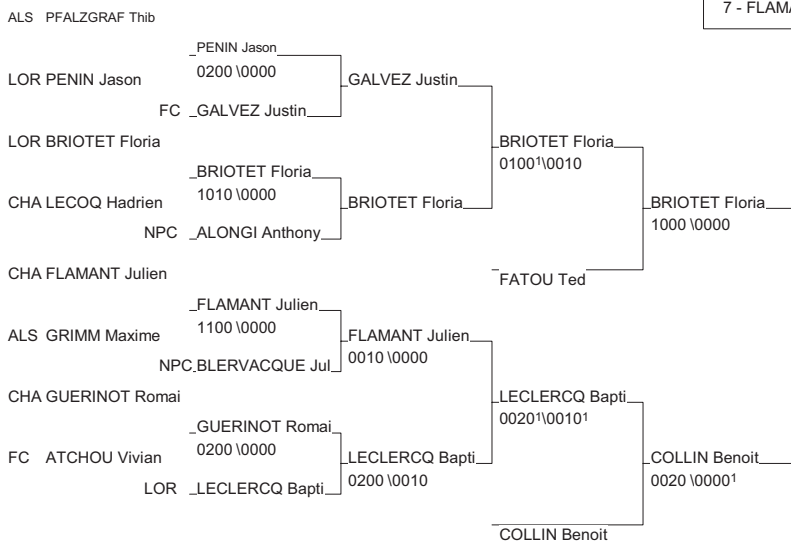

DEMI FINALE CHPT FRANCE JUNIORS

ST DIE DES VOSGES 15/03/2009-15/03/2009

Cat. -81

Nb. Judokas : 30

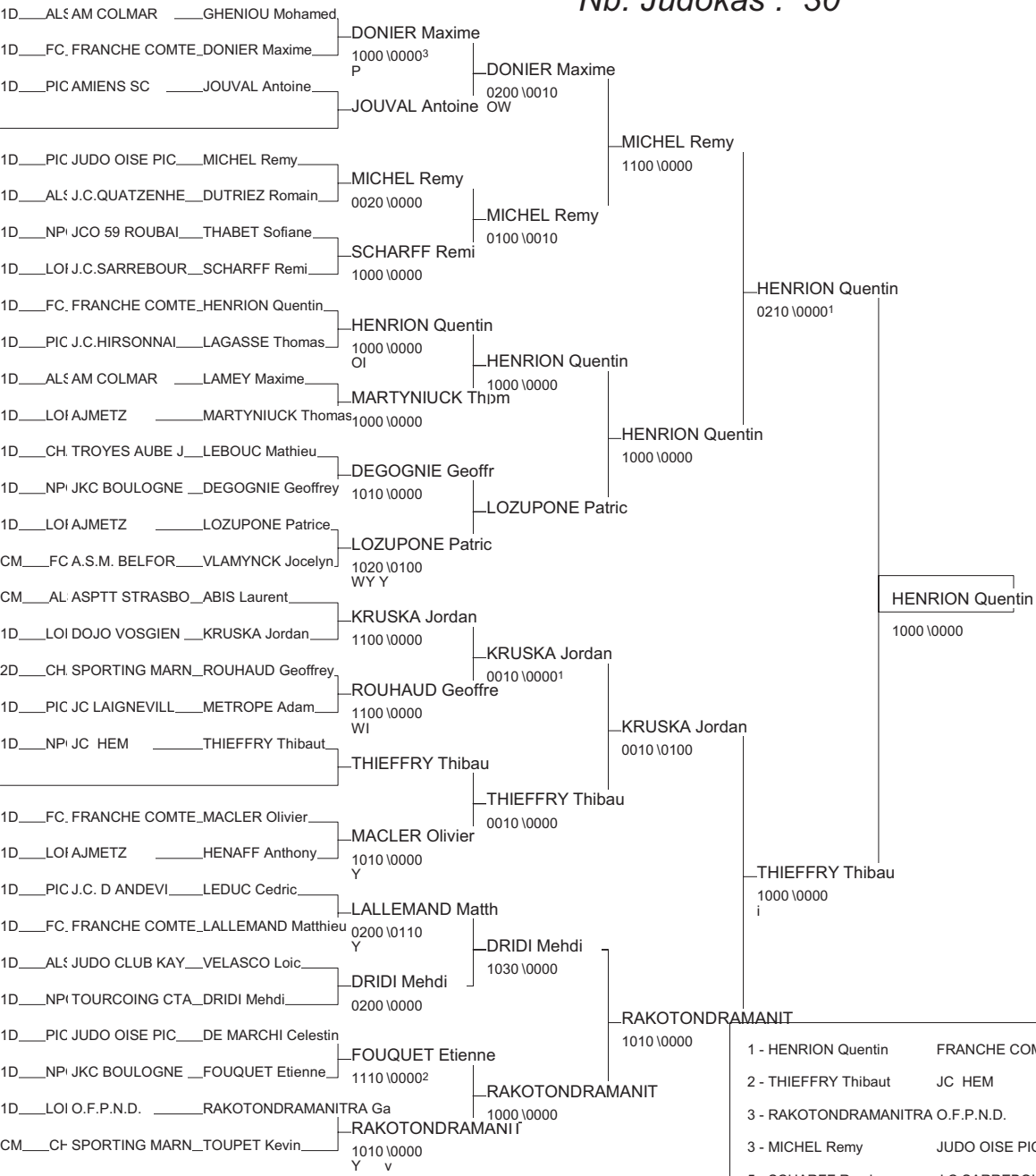

1 - HENRION Quentin	FRANCHE COMTE FC	FC
2 - THIEFFRY Thibaut	JC HEM NPC	NPC
3 - RAKOTONDAMANITRA O.F.P.N.D.	LORR	LOR
3 - MICHEL Remy	JUDO OISE PIC PIC	PIC
5 - SCHARFF Remi	J.C.SARREBOURG LORR	LOR
5 - KRUSKA Jordan	DOJO VOSGIEN LORR	LOR
7 - LOZUPONE Patrice	AJMETZ LORR	LOR
7 - FOUQUET Etienne	JKC BOULOGNE NPC	NPC

ALS DUTRIEZ Romain

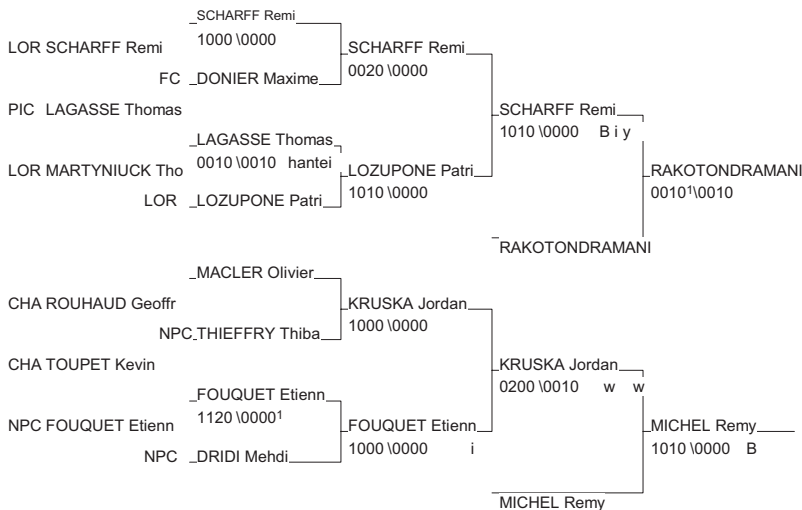

DEMI FINALE CHPT FRANCE JUNIORS

ST DIE DES VOSGES 15/03/2009-15/03/2009

Cat. -90

Nb. Judokas : 18

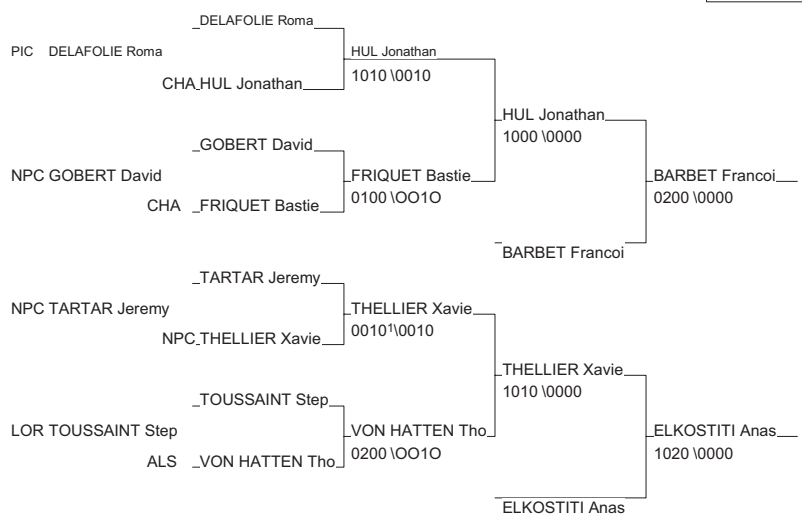
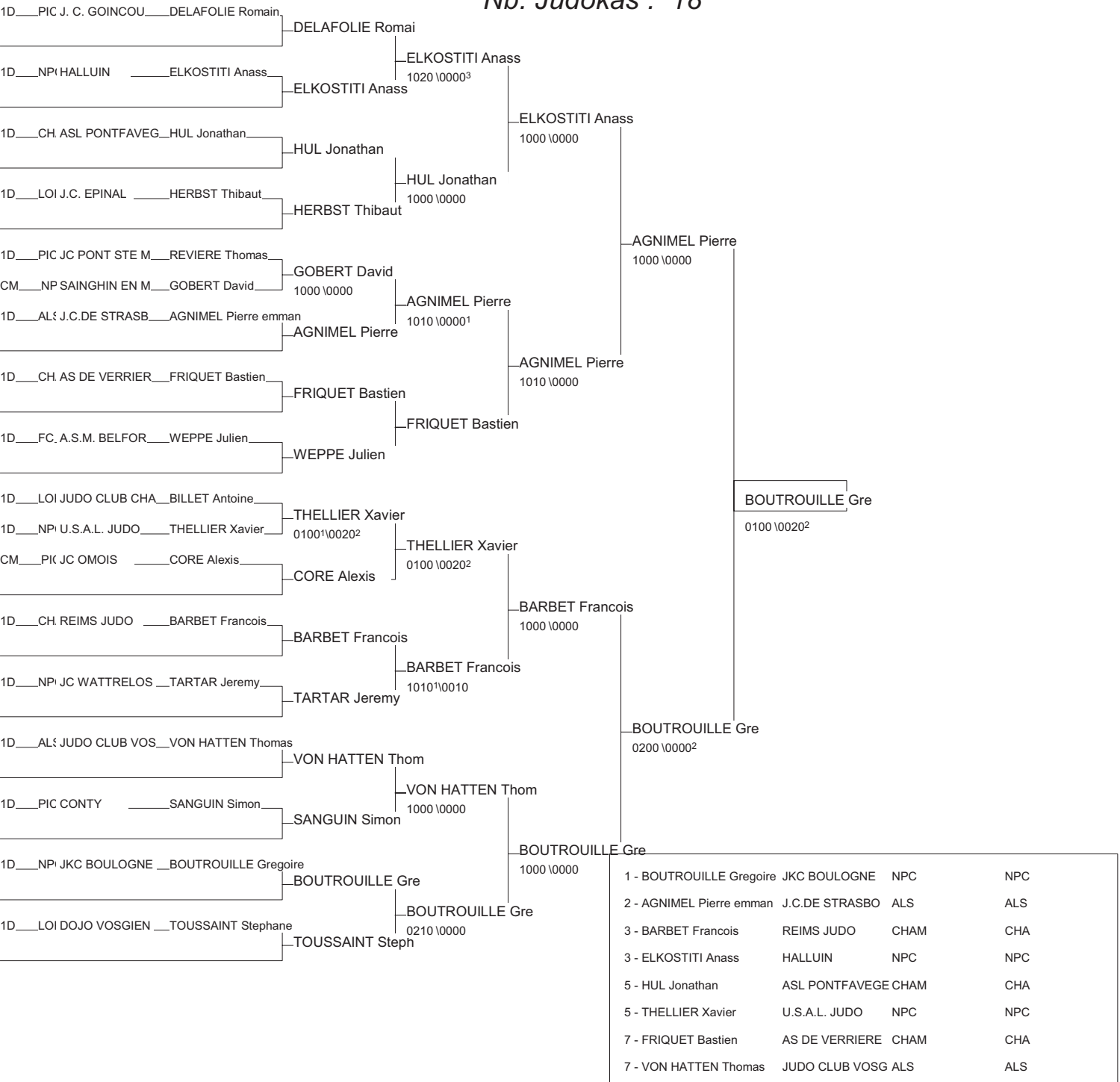

DEMI FINALE CHPT FRANCE JUNIORS

ST DIE DES VOSGES 15/03/2009-15/03/2009

Cat. -100

Nb. Judokas : 18

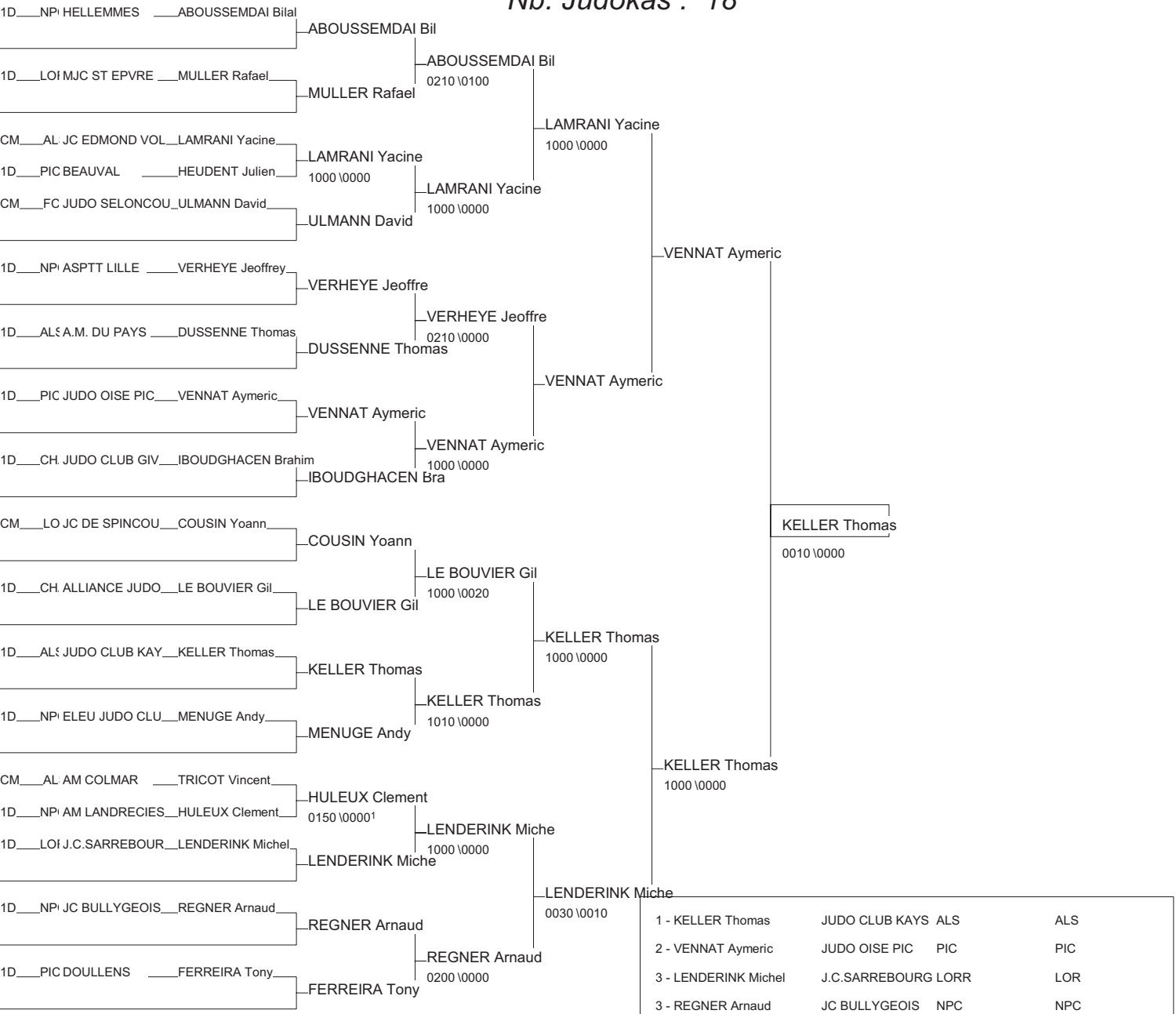

1 - KELLER Thomas	JUDO CLUB KAYS ALS	ALS
2 - VENNAT Aymeric	JUDO OISE PIC PIC	PIC
3 - LENDERINK Michel	J.C.SARREBOURG LORR	LOR
3 - REGNER Arnaud	JC BULLYGEOIS NPC	NPC
5 - VERHEYE Jeffrey	ASPTT LILLE NPC	NPC
5 - LAMRANI Yacine	JC EDMOND VOLL ALS	ALS
7 - ABOUSSEMDAI Bilal	HELLEMES NPC	NPC
7 - MENUGE Andy	ELEU JUDO CLUB NPC	NPC

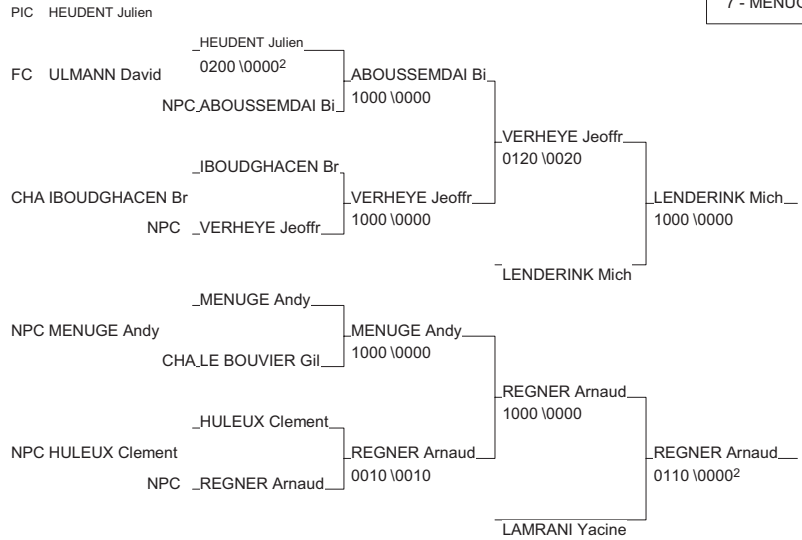

DEMI FINALE CHPT FRANCE JUNIORS

ST DIE DES VOSGES 15/03/2009-15/03/2009

Cat. +100

Nb. Judokas : 11

