



EJU World Cup Bucharest 2008

(ROU Bucharest, 7-8 June 2008)

-48 kg

6 Judoka

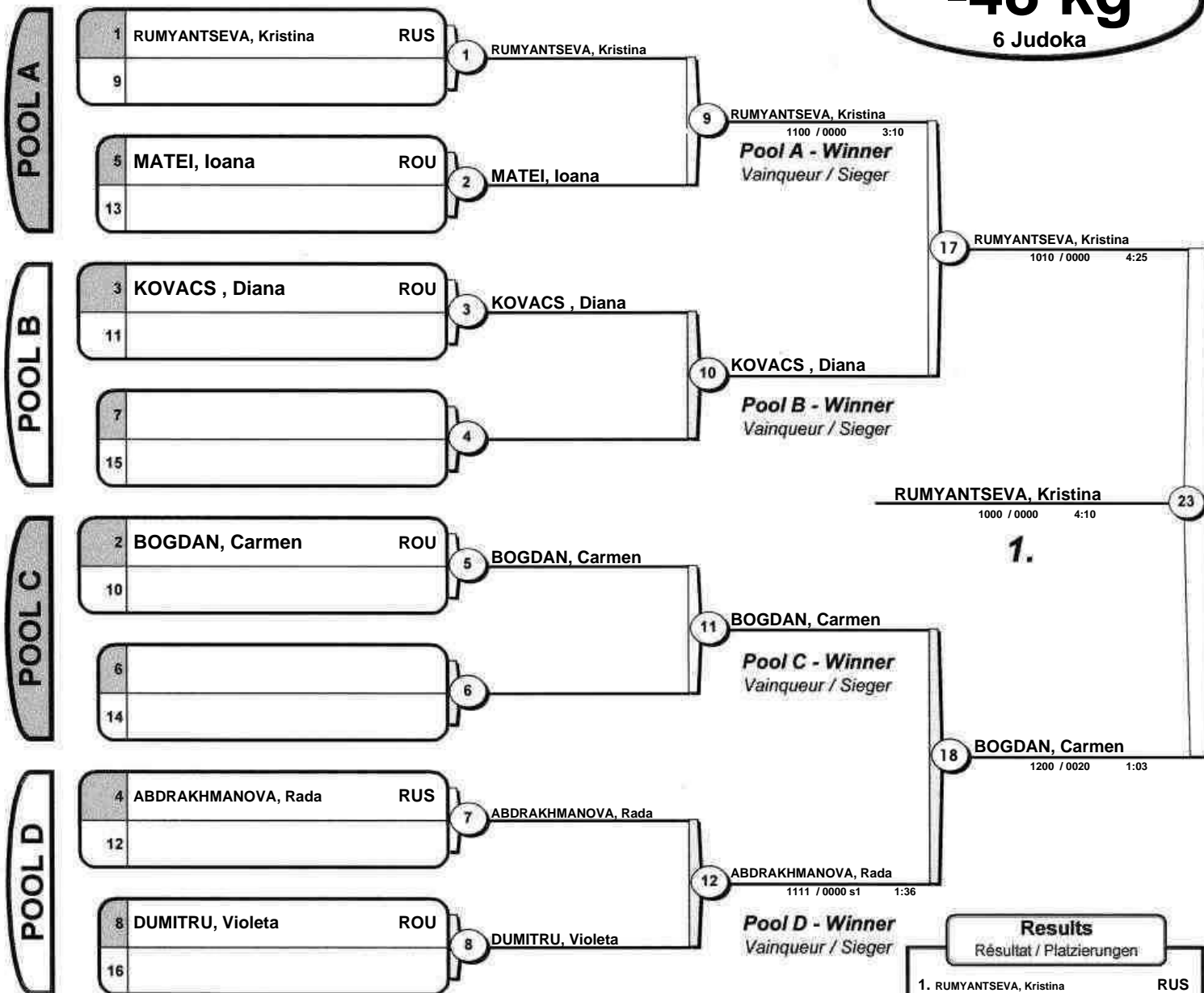

Results	
Résultat / Platzierungen	
1.	RUMYANTSEVA, Kristina (RUS)
2.	BOGDAN, Carmen (ROU)
3.	ABDRAKHMANOVA, Rada (RUS)
3.	KOVACS, Diana (ROU)
5.	MATEI, Ioana (ROU)
5.	DUMITRU, Violeta (ROU)
7.	
7.	

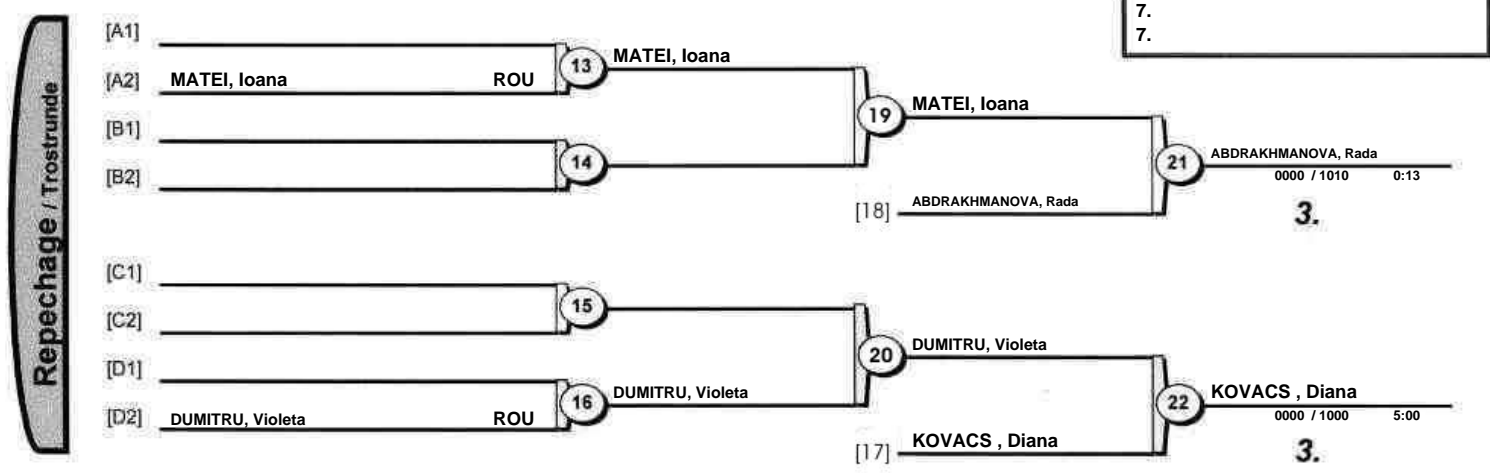



EJU World Cup Bucharest 2008

(ROU Bucharest, 7-8 June 2008)

-52 kg

8 Judoka

POOL A

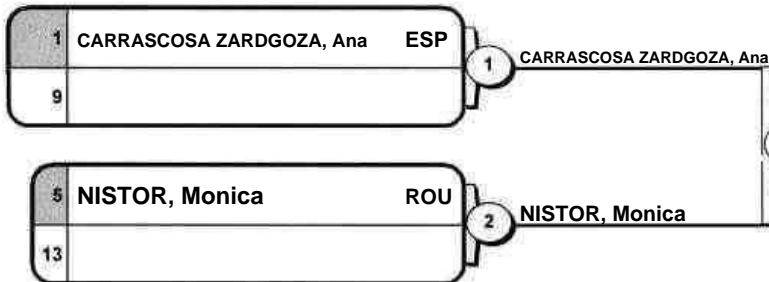

POOL B

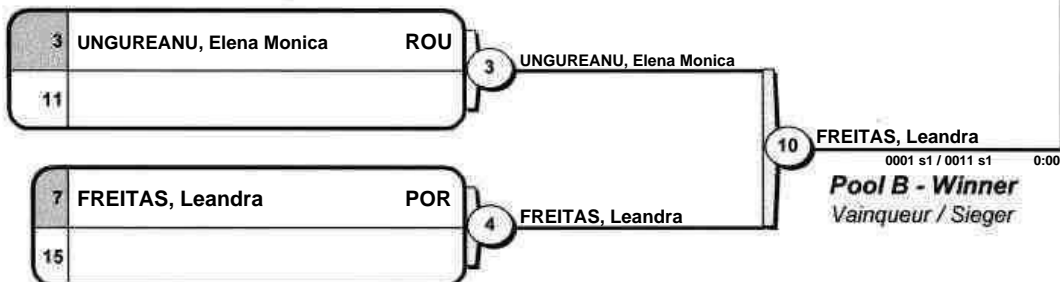

POOL C

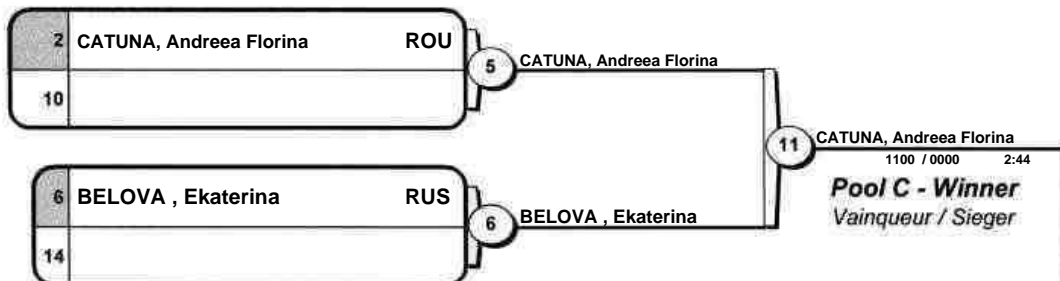

POOL D



Results	
Résultat / Platzierungen	
1. CARRASCOSA ZARDGOZA, Ana	ESP
2. HORMIGO, Ana	POR
3. NISTOR, Monica	ROU
3. FREITAS, Leandra	POR
5. CATUNA, Andreea Florina	ROU
5. BELOVA, Ekaterina	RUS
7. UNGUREANU, Elena Monica	ROU
7. MLADIN, Diana	ROU

Repechage / Trostrunde

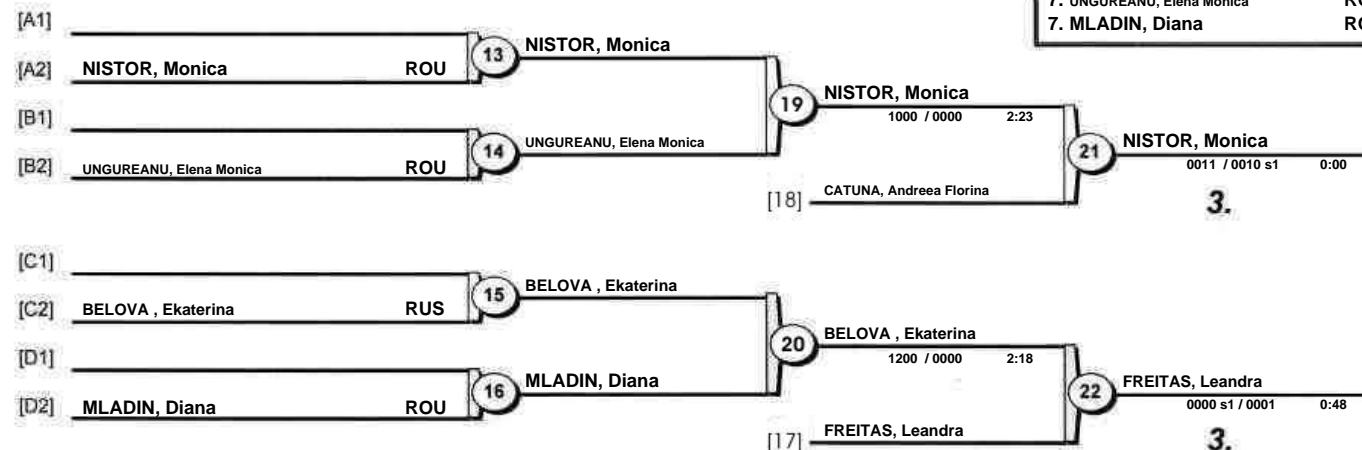



EJU World Cup Bucharest 2008

(ROU Bucharest, 7-8 June 2008)

-57 kg

7 Judoka

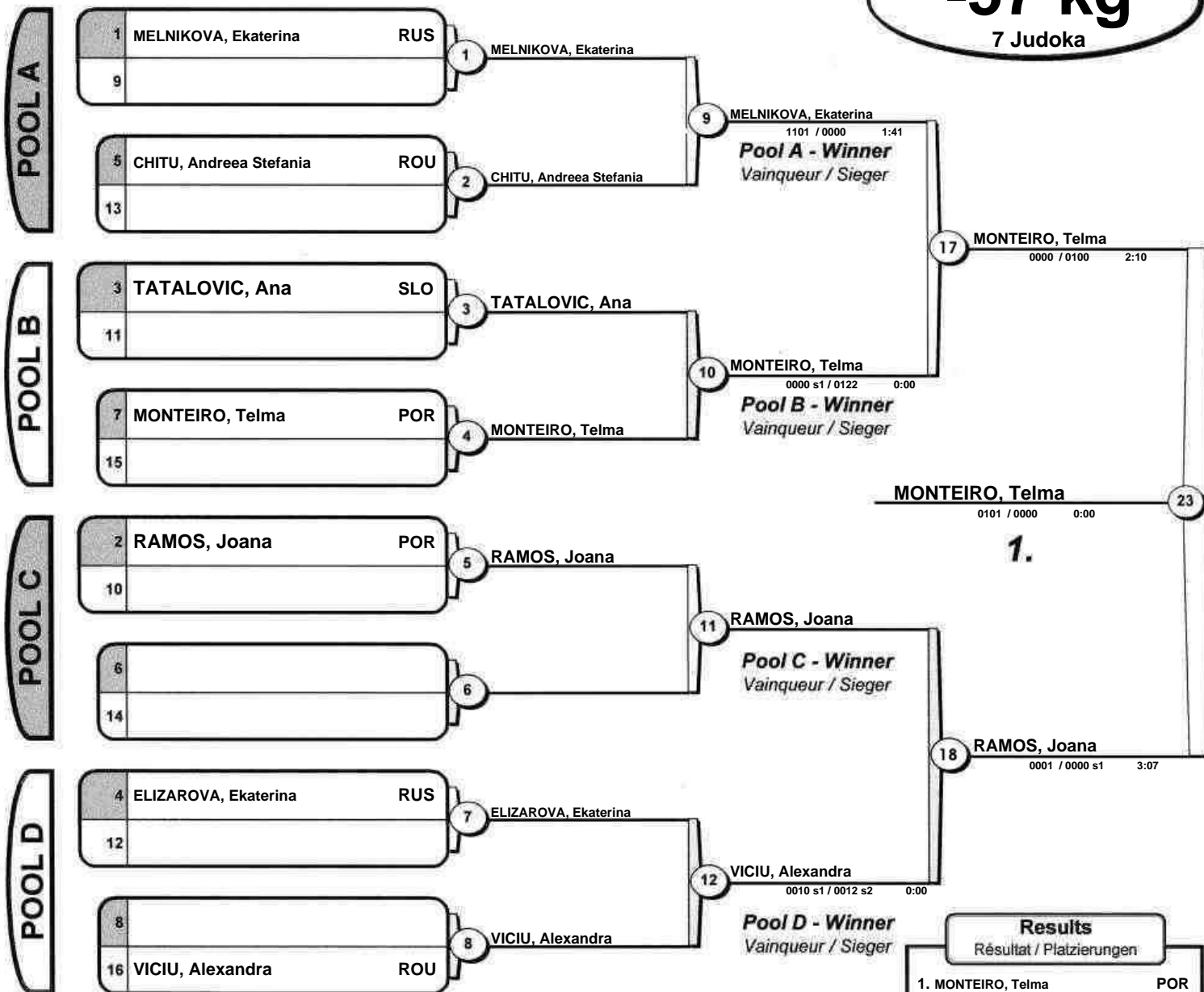

Results	
Résultat / Platzierungen	
1.	MONTEIRO, Telma POR
2.	RAMOS, Joana POR
3.	VICIU, Alexandra ROU
3.	ELIZAROVA, Ekaterina RUS
5.	CHITU, Andreea Stefania ROU
5.	MELNIKOVA, Ekaterina RUS
7.	TATALOVIC, Ana SLO

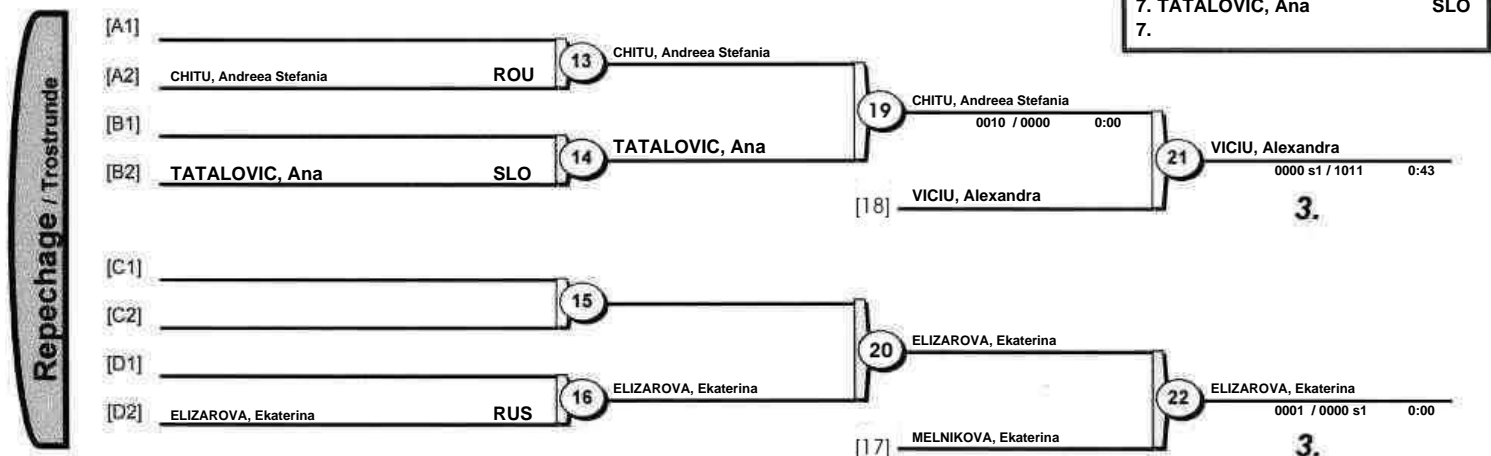



EJU World Cup Bucharest 2008

(ROU Bucharest, 7-8 June 2008)

-63 kg

8 Judoka

POOL A

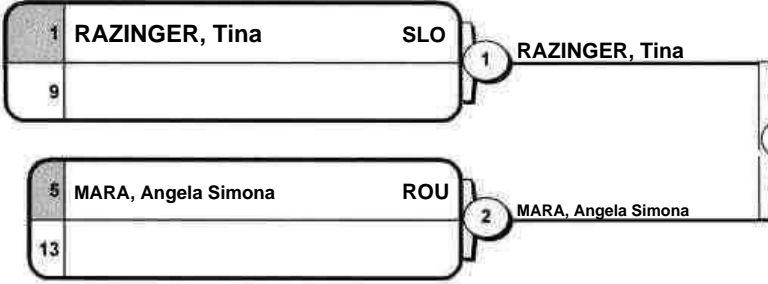

POOL B

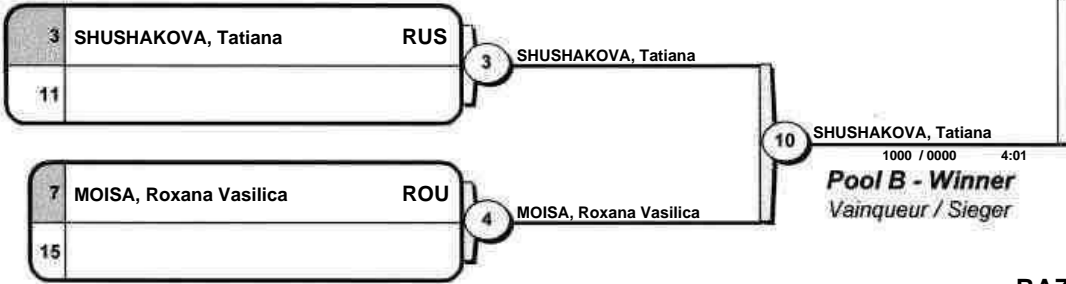

POOL C

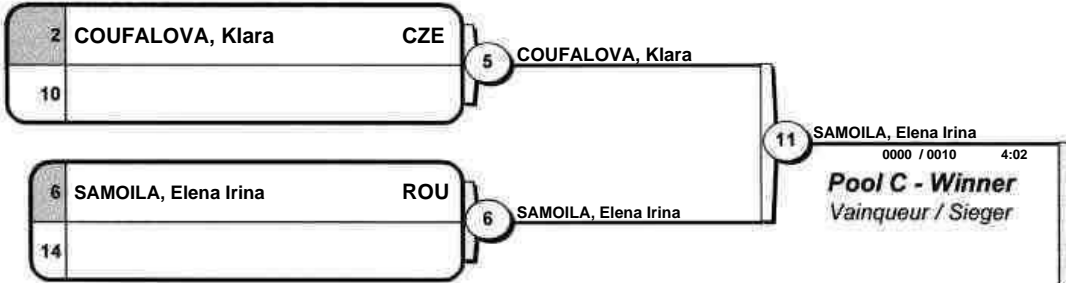

POOL D

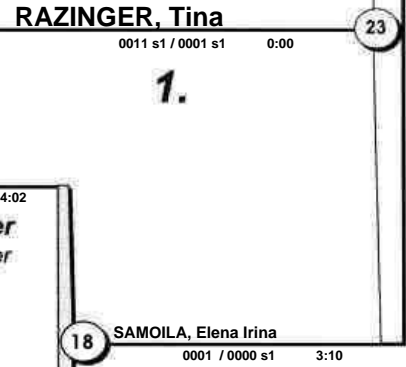
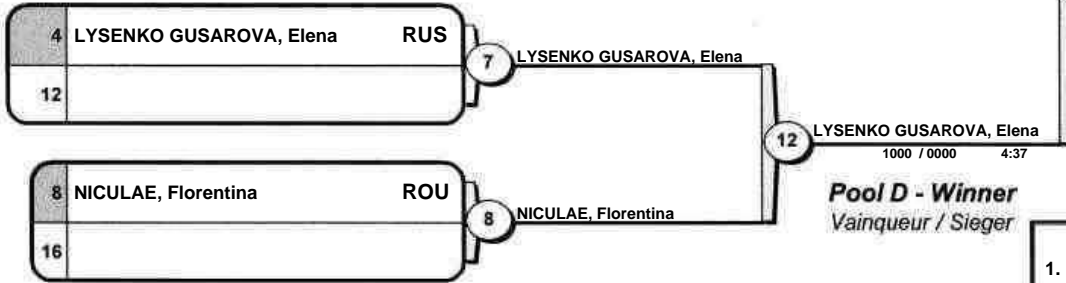

Results R sultat / Platzierungen

- | | | |
|----|-------------------------|-----|
| 1. | RAZINGER, Tina | SLO |
| 2. | SAMOILA, Elena Irina | ROU |
| 3. | LYSENKO GUSAROVA, Elena | RUS |
| 3. | SHUSHAKOVA, Tatiana | RUS |
| 5. | MARA, Angela Simona | ROU |
| 5. | COUFALOVA, Klara | CZE |
| 7. | MOISA, Roxana Vasilica | ROU |
| 7. | NICULAE, Florentina | ROU |

Repechage / Trostrunde

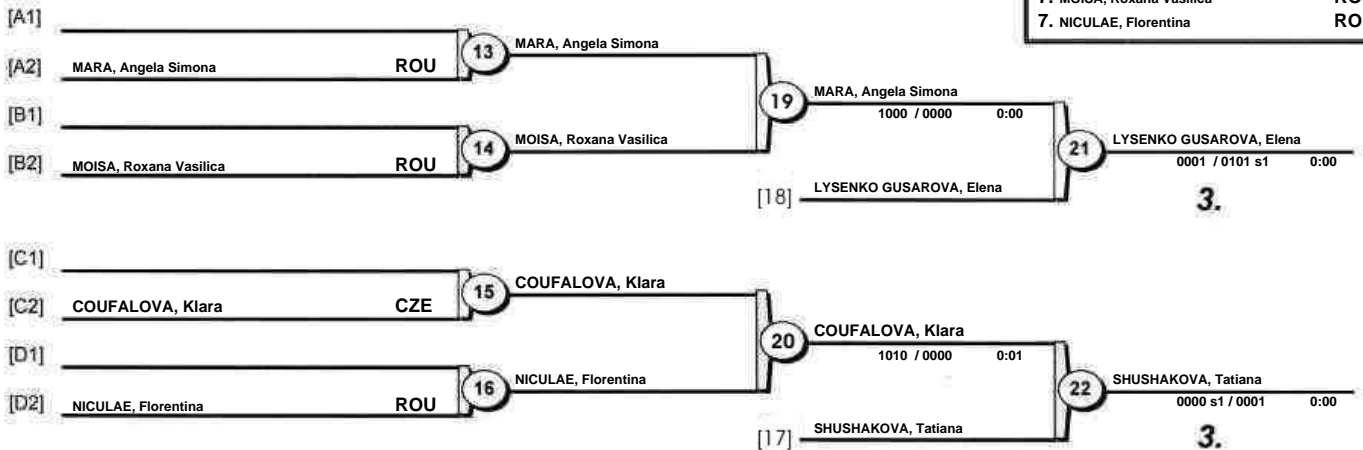



EJU World Cup Bucharest 2008

(ROU Bucharest, 7-8 June 2008)

-70 kg

6 Judoka

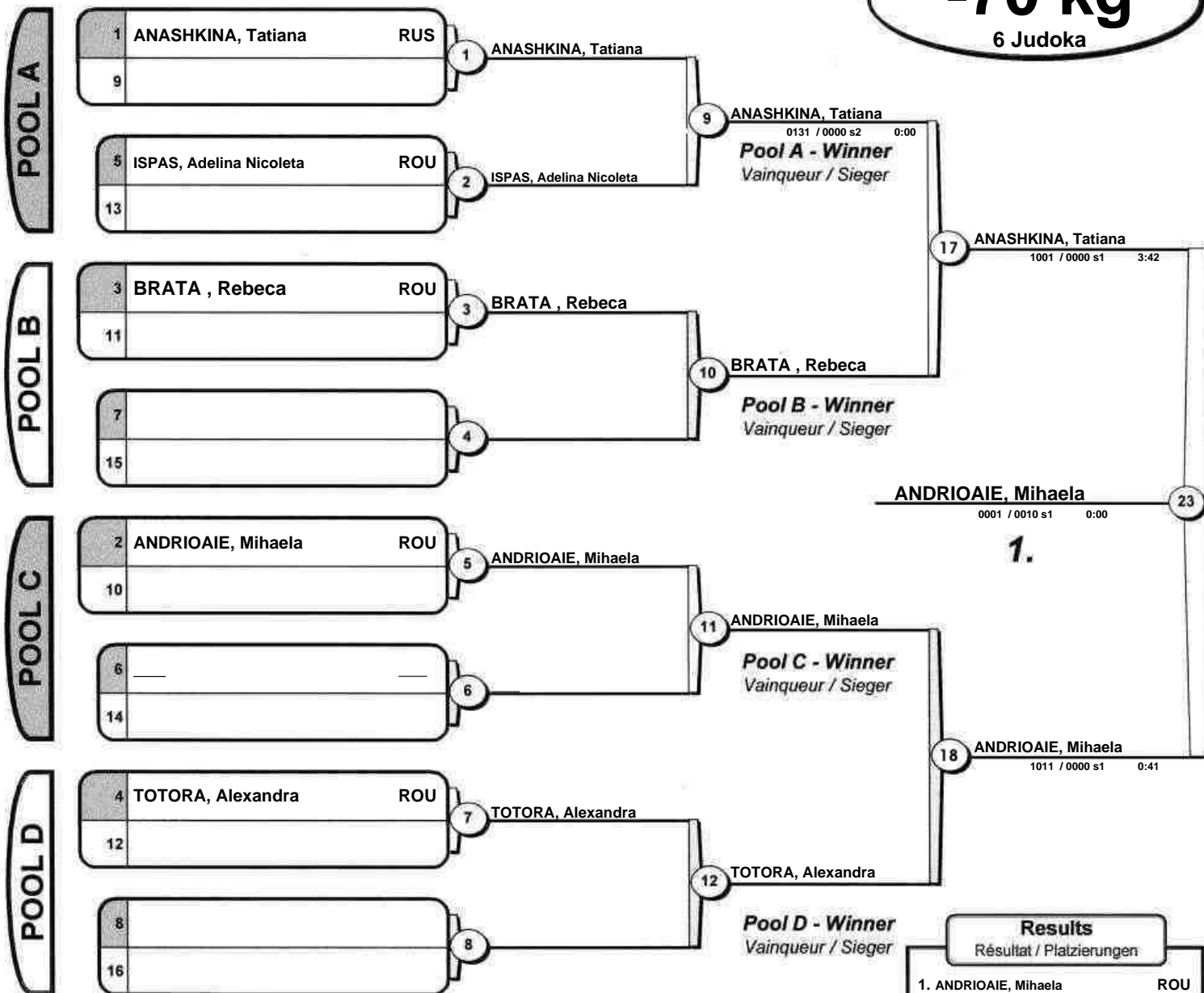

Results	
Résultat / Platzierungen	
1. ANDRIOAIE, Mihaela	ROU
2. ANASHKINA, Tatiana	RUS
3. ISPAS, Adelina Nicoleta	ROU
3. BRATA, Rebeca	ROU
5. TOTORA, Alexandra	ROU
5. _____	_____
7. _____	_____
7. _____	_____

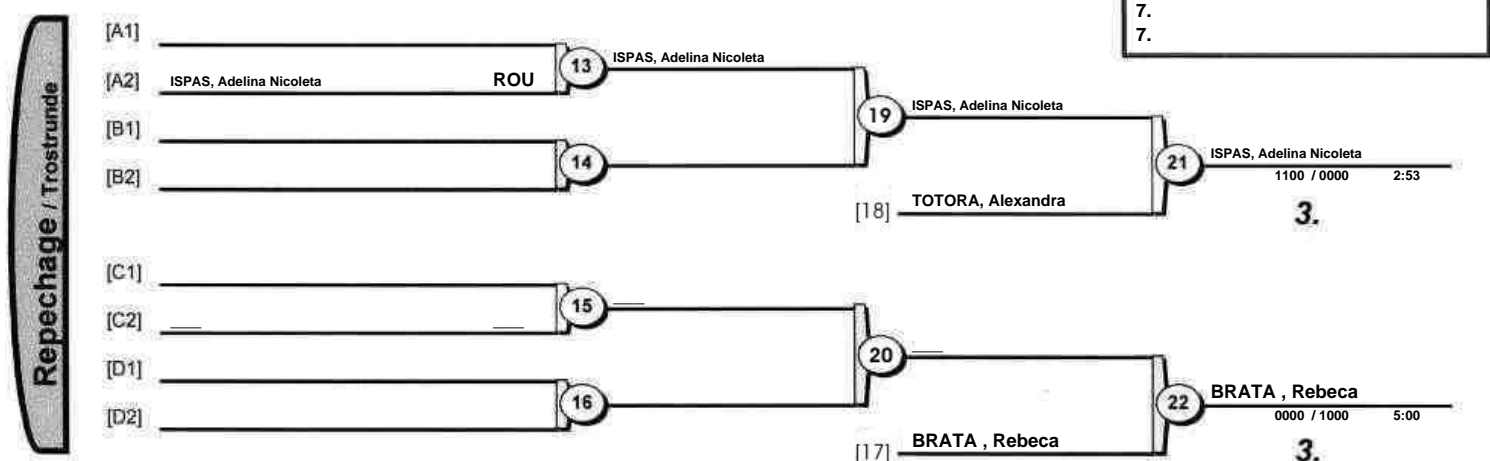



EJU World Cup Bucharest 2008

(ROU Bucharest, 7-8 June 2008)

-78 kg

6 Judoka

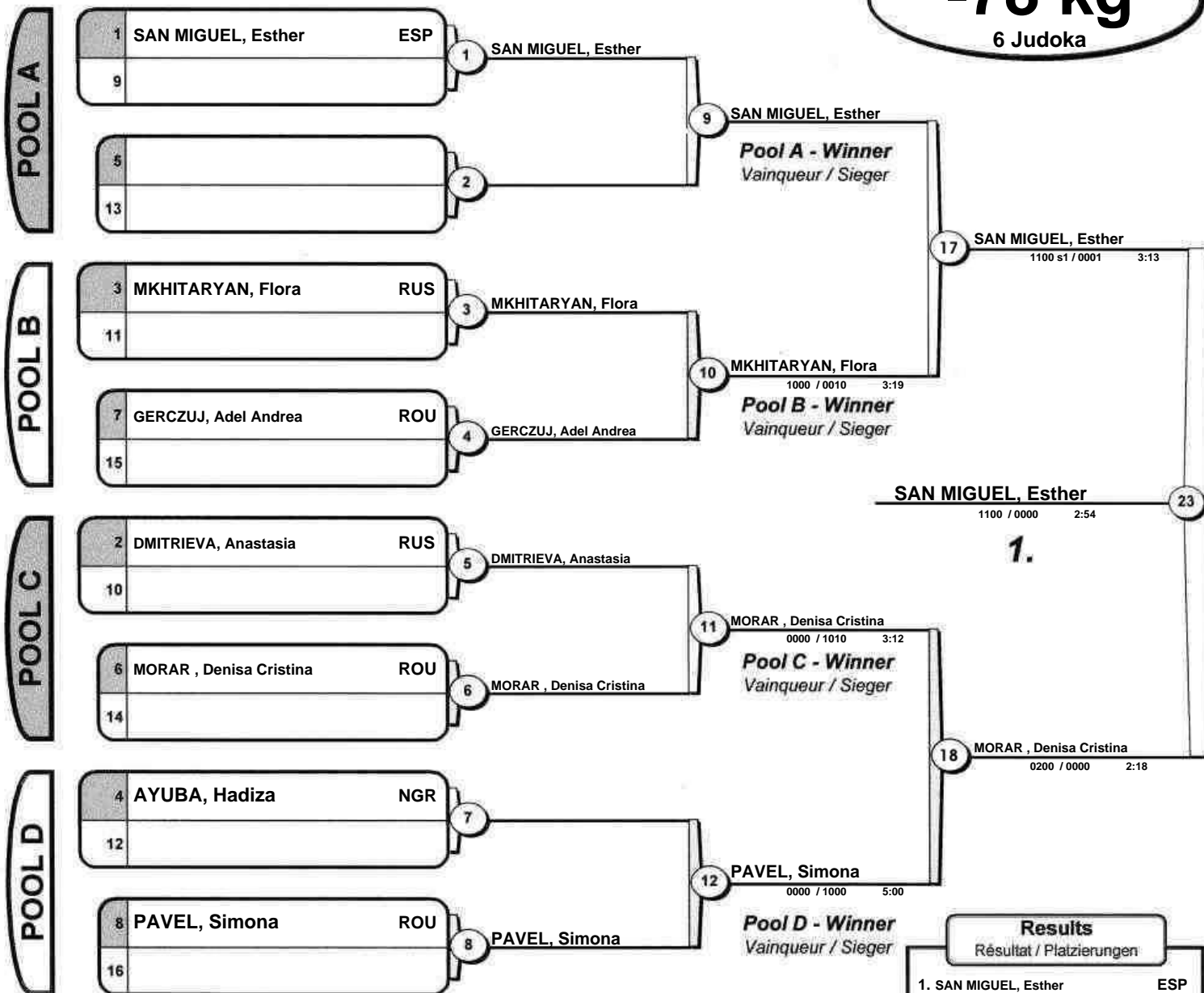

Results	
Résultat / Platzierungen	
1.	SAN MIGUEL, Esther (ESP)
2.	MORAR, Denisa Cristina (ROU)
3.	PAVEL, Simona (ROU)
4.	DMITRIEVA, Anastasia (RUS)
5.	GERCZUJ, Adel Andrea (ROU)
6.	MKHITARYAN, Flora (RUS)
7.	
7.	

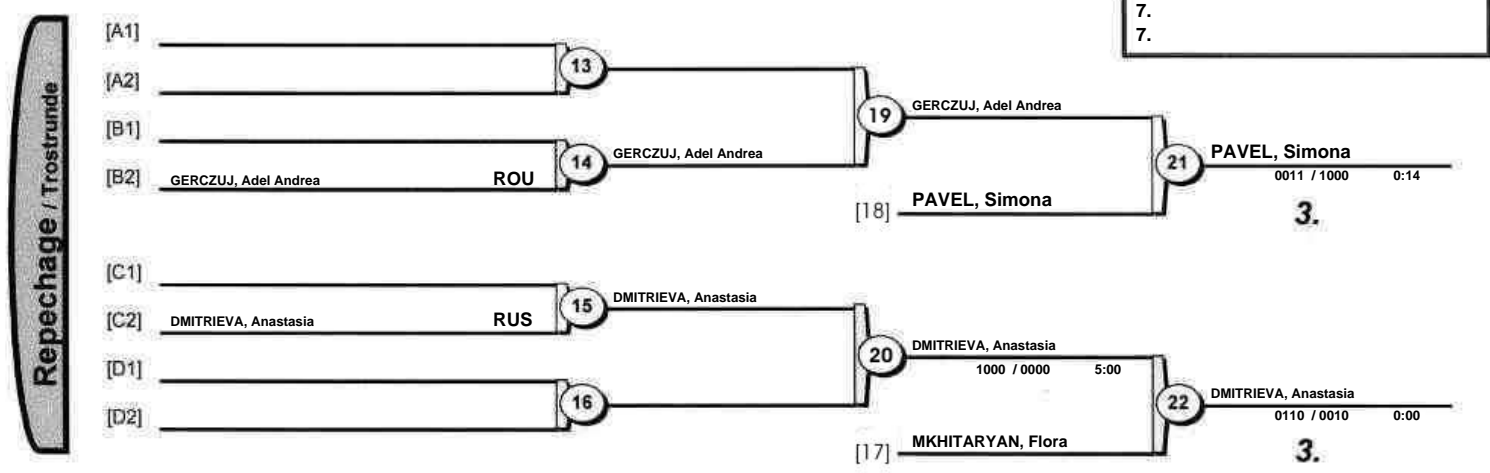



EJU World Cup Bucharest 2008

(ROU Bucharest, 7-8 June 2008)

+78 kg

6 Judoka

POOL A

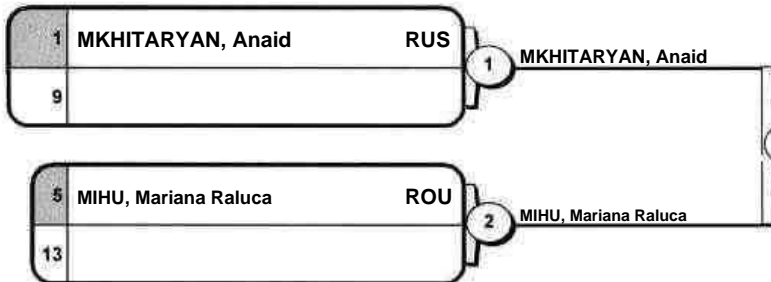

9 MKHITARYAN, Anaid
1010 / 0000 s2 1:25
Pool A - Winner
Vainqueur / Sieger

POOL B

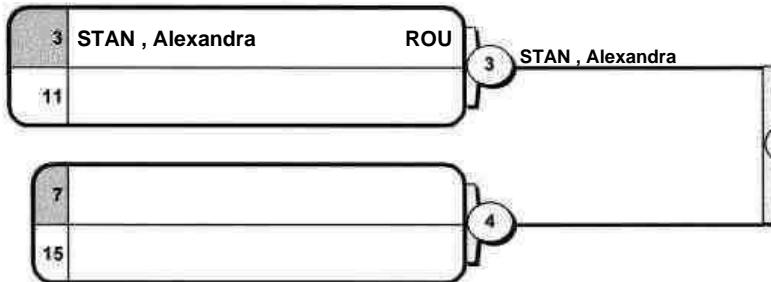

10 STAN, Alexandra
Pool B - Winner
Vainqueur / Sieger

POOL C

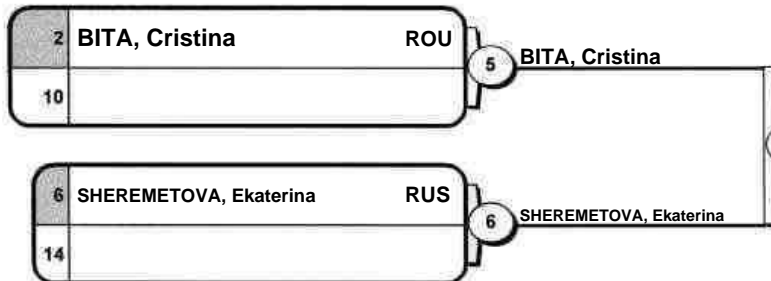

11 SHEREMETOVA, Ekaterina
0000 s2 / 1020 0:00
Pool C - Winner
Vainqueur / Sieger

POOL D

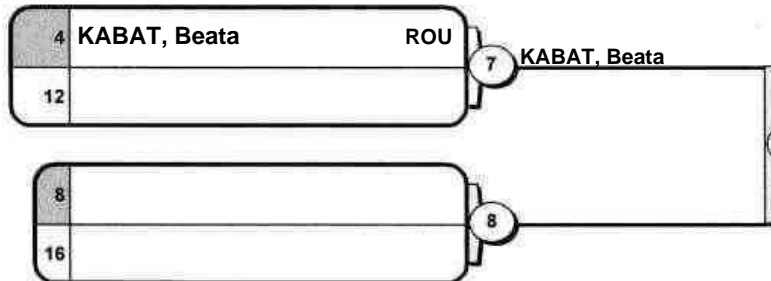

12 KABAT, Beata
Pool D - Winner
Vainqueur / Sieger

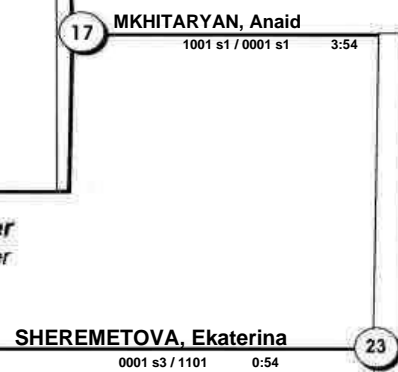

23
1.
18 SHEREMETOVA, Ekaterina
1000 / 0000 4:40

Results	
R�sultat / Platzierungen	
1.	SHEREMETOVA, Ekaterina RUS
2.	MKHITARYAN, Anaid RUS
3.	KABAT, Beata ROU
3.	STAN, Alexandra ROU
5.	MIHU, Mariana Raluca ROU
5.	BITA, Cristina ROU
7.	
7.	

Repechage / Trostrunde

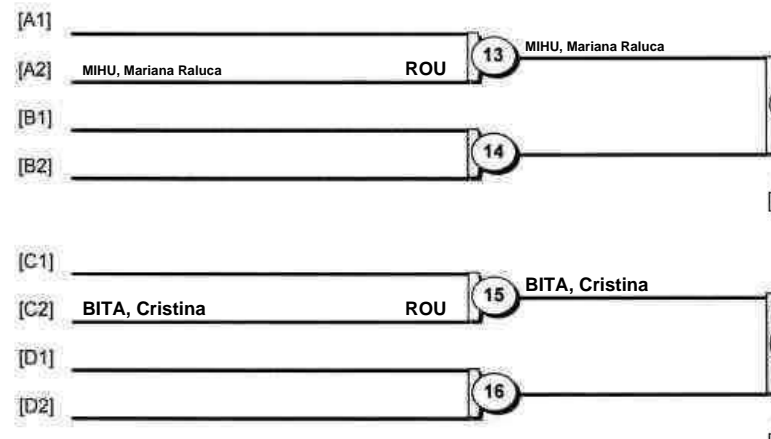

13 MIHU, Mariana Raluca
19 MIHU, Mariana Raluca
14
21 KABAT, Beata
0000 / 1000 2:56
[18] KABAT, Beata
3.

15 BITA, Cristina
20 BITA, Cristina
16
22 STAN, Alexandra
0001 / 1000 s1 4:02
[17] STAN, Alexandra
3.