



African Open Port Louis MRI 2013

Port Louis (MRI) 9-10 November 2013

-60 kg

9 Judoka

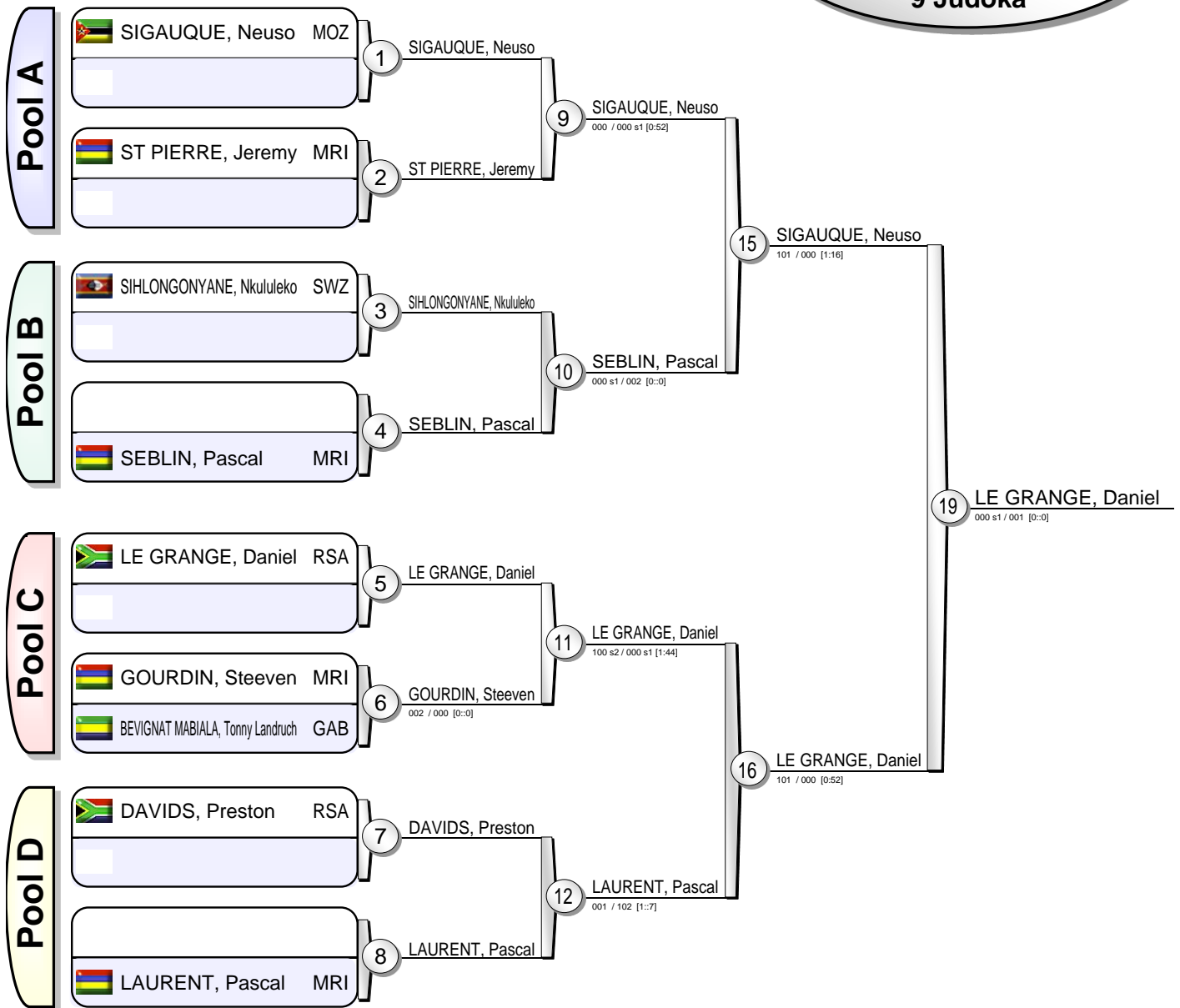

Results		
1.	LE GRANGE, Daniel	RSA
2.	SIGAUQUE, Neuso	MOZ
3.	LAURENT, Pascal	MRI
3.	GOURDIN, Steeven	MRI
5.	ST PIERRE, Jeremy	MRI
5.	SEBLIN, Pascal	MRI
7.	SIHLONGONYANE, Nkululeko	SWZ
7.	DAVIDS, Preston	RSA

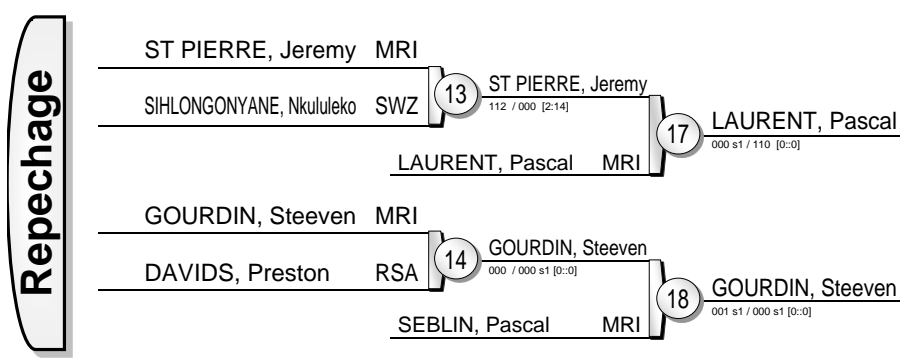



African Open Port Louis MRI 2013

Port Louis (MRI) 9-10 November 2013

-66 kg

8 Judoka

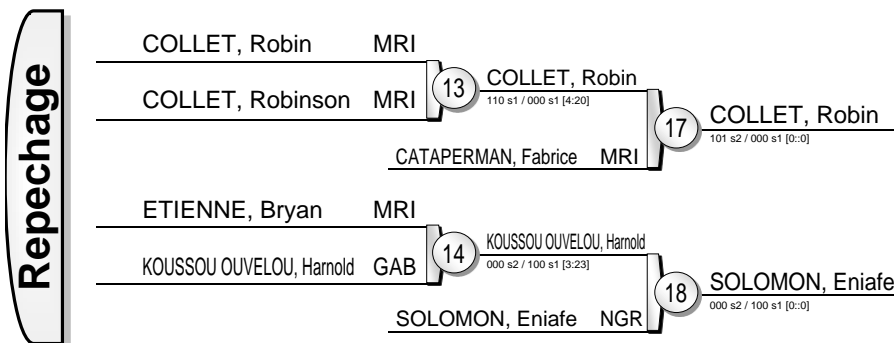

Results		
1.	KEEBLE, Lewis	GBR
2.	MABULU, Siyabulela	RSA
3.	COLLET, Robin	MRI
3.	SOLOMON, Eniafe	NGR
5.	CATAPERMAN, Fabrice	MRI
5.	KOUSSOU OUVELOU, Harmold	GAB
7.	COLLET, Robinson	MRI
7.	ETIENNE, Bryan	MRI





African Open Port Louis MRI 2013

Port Louis (MRI) 9-10 November 2013

-73 kg

12 Judoka

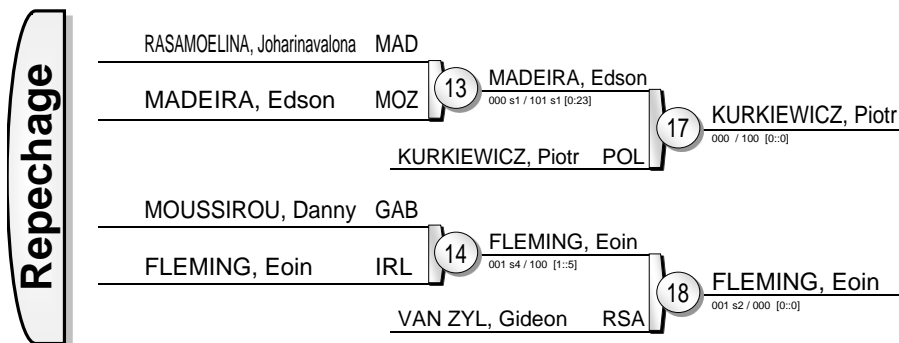

Results		
1.	NARTEY, Emmanuel	GHA
2.	THOMPSON, Caoimhin	IRL
3.	KURKIEWICZ, Piotr	POL
3.	FLEMING, Eoin	IRL
5.	MADEIRA, Edson	MOZ
5.	VAN ZYL, Gideon	RSA
7.	RASAMOELINA, Joharinaivalona	MAD
7.	MOUSSIROU, Danny	GAB





African Open Port Louis MRI 2013

Port Louis (MRI) 9-10 November 2013

-81 kg

8 Judoka

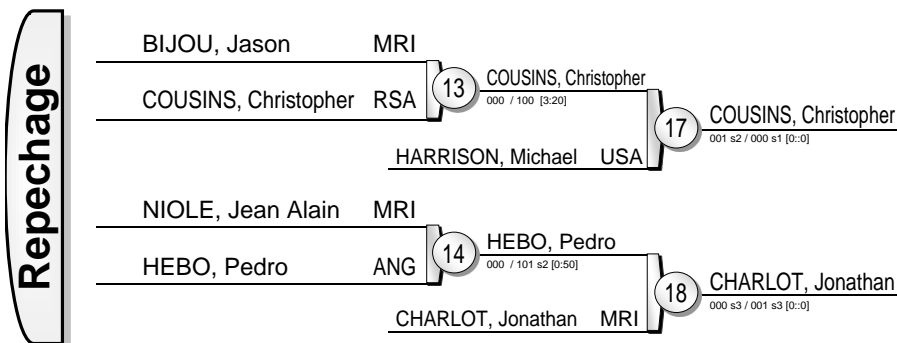
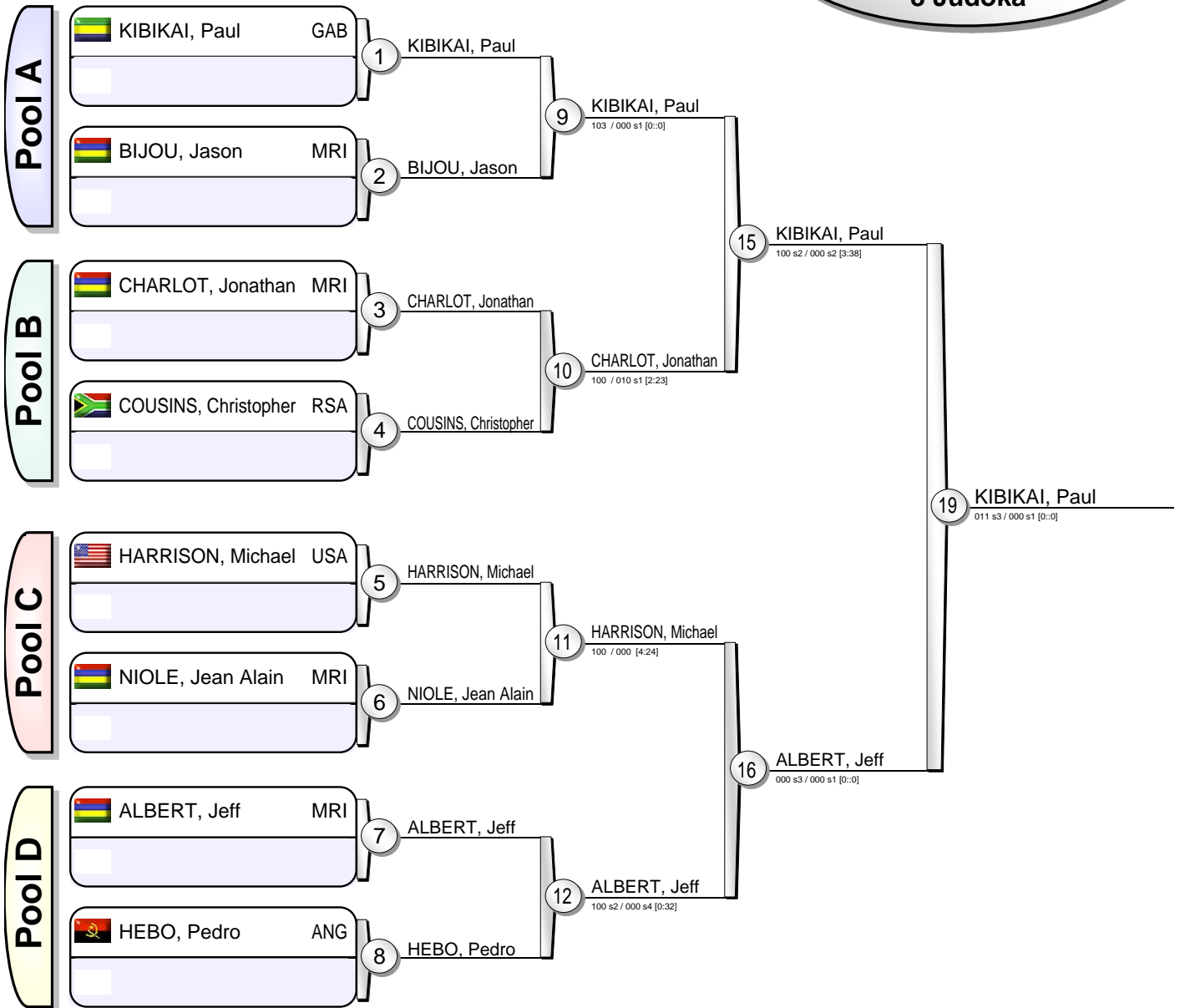

Results		
1.	KIBIKAI, Paul	GAB
2.	ALBERT, Jeff	MRI
3.	COUSINS, Christopher	RSA
3.	CHARLOT, Jonathan	MRI
5.	HARRISON, Michael	USA
5.	HEBO, Pedro	ANG
7.	BIJOU, Jason	MRI
7.	NIOLE, Jean Alain	MRI





African Open Port Louis MRI 2013

Port Louis (MRI) 9-10 November 2013

-90 kg

5 Judoka

			1	3	5	Wins	Scores
1	BESEQUE, Dany	MRI		-	-	0	(0)
3	DULMAR, Shane	MRI	+		-	1	(10)
5	AHIAVOR, Victor	GHA	+	+		2	(20)

			2	4	Wins	Scores
2	PIONTEK, Zack	RSA		+	1	(10)
4	BAPTISTE, Jeekenty	MRI	-		0	(0)

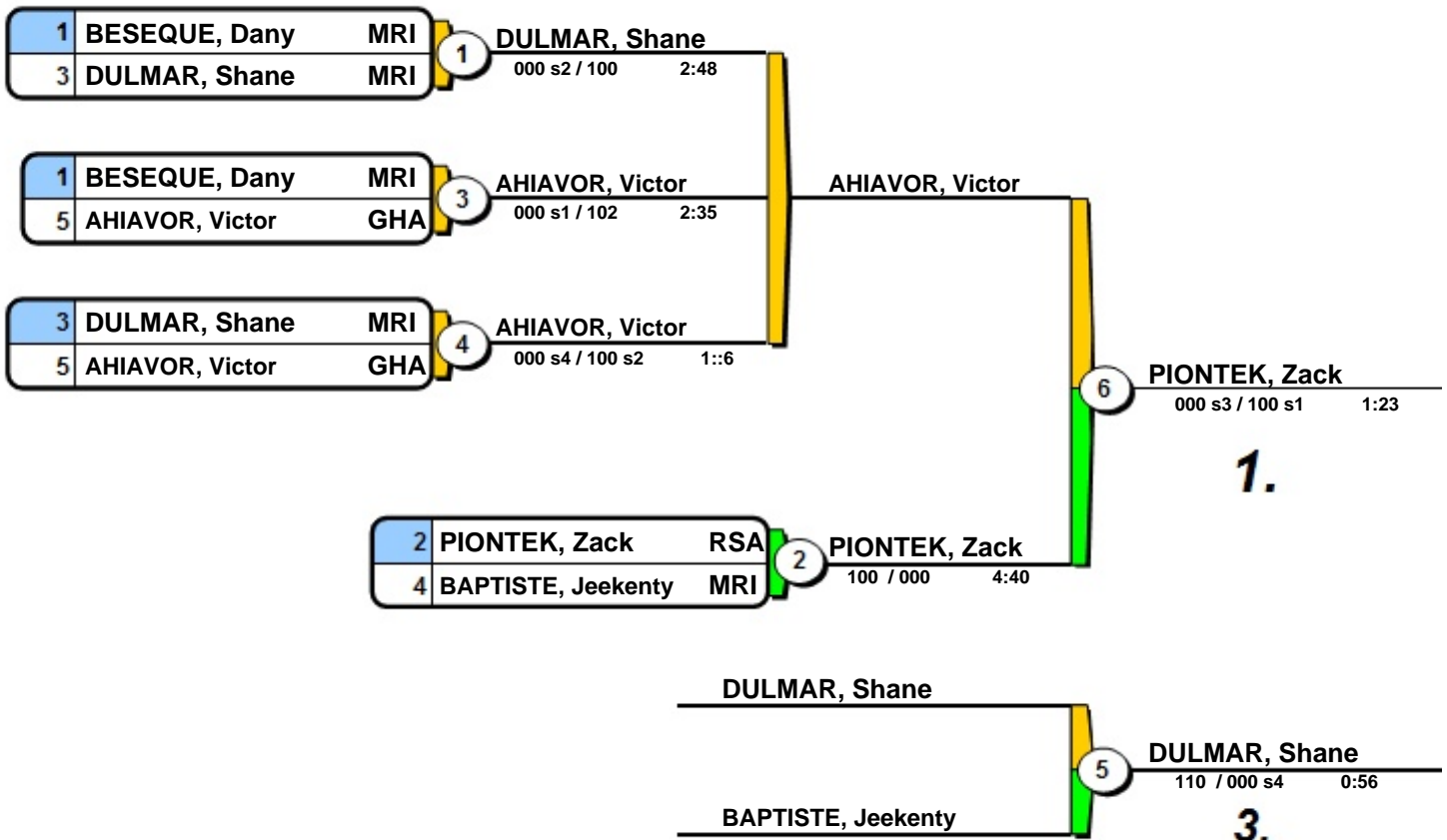

- | | | |
|----|-----------------|-----|
| 1. | PIONTEK, Zack | RSA |
| 2. | AHIAVOR, Victor | GHA |
| 3. | DULMAR, Shane | MRI |



African Open Port Louis MRI 2013

Port Louis (MRI) 9-10 November 2013

-100 kg
4 Judoka

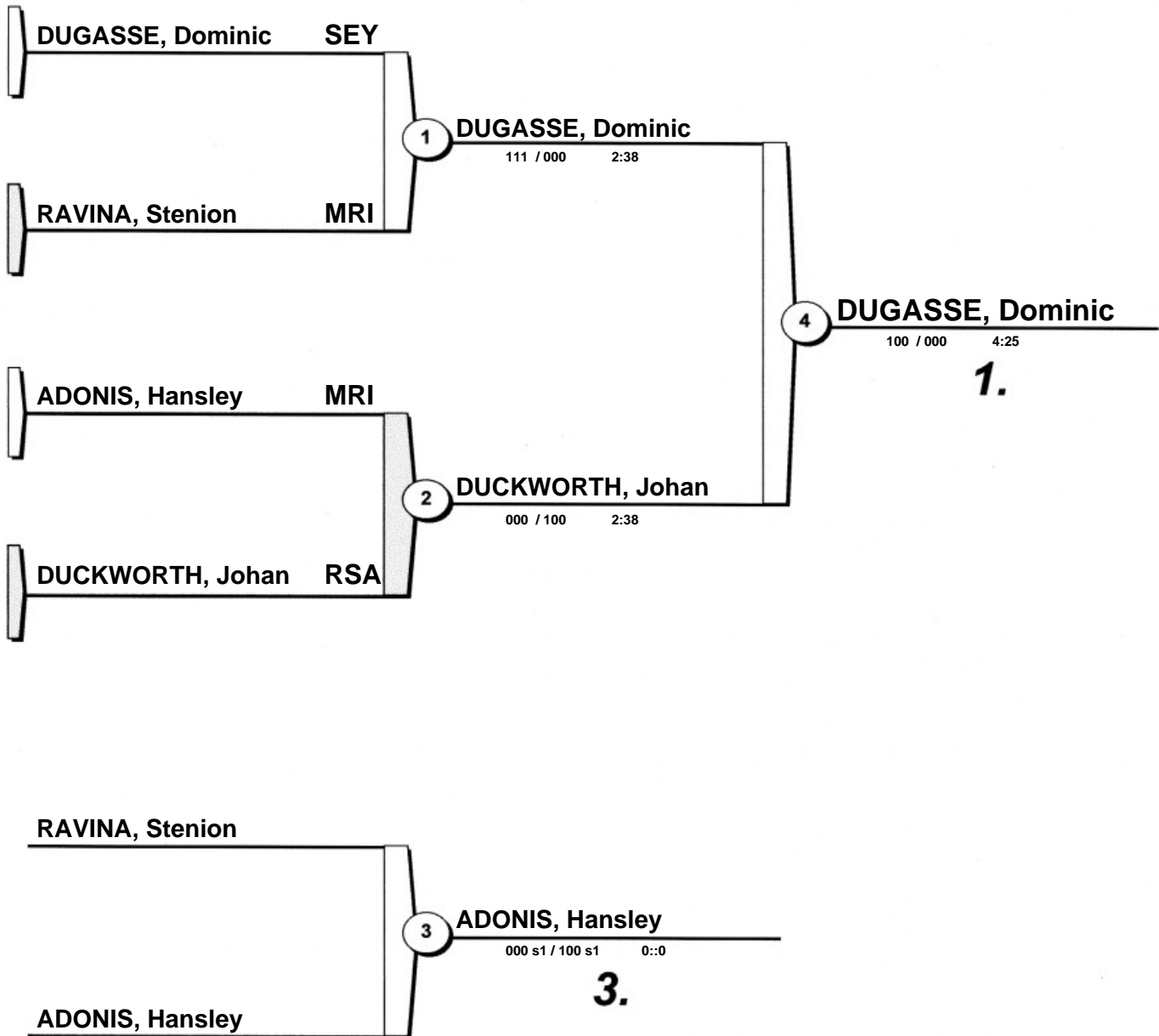

- 1. DUGASSE, Dominic SEY
- 2. DUCKWORTH, Johan RSA
- 3. ADONIS, Hansley MRI



African Open Port Louis MRI 2013

Port Louis (MRI) 9-10 November 2013

+100 kg

2 Judoka

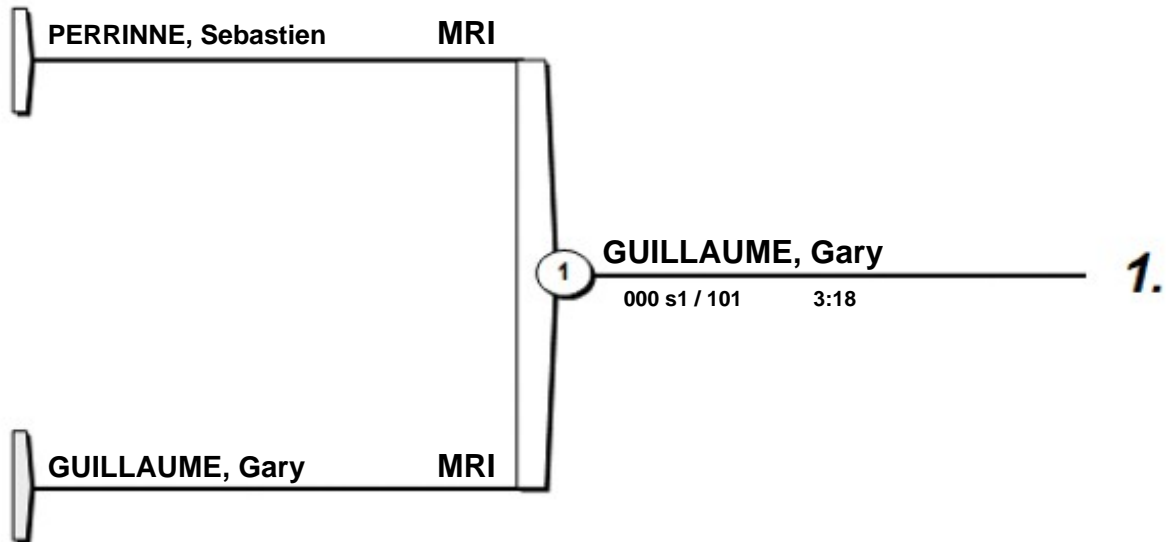

1. GUILLAUME, Gary

MRI