



African Open Port Louis MRI 2013

Port Louis (MRI) 9-10 November 2013

-48 kg

9 Judoka



Results		
1.	LIMA, Taciana	GBS
2.	RENICKS, Kimberley	GBR
3.	EWALA BONDIME, Esther Corine	GAB
3.	WILLIS, Hayley	GBR
5.	MBAZOGHE, Sandrine	GAB
5.	FRANCOIS, Stacy	MRI
7.	RAKOTOBÉ, Ny Akanto	MAD
7.	LOUMEAU, Laetitia	MRI

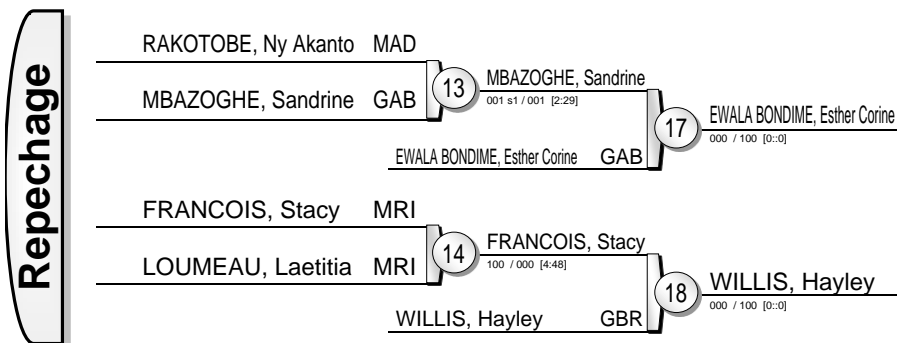



African Open Port Louis MRI 2013

Port Louis (MRI) 9-10 November 2013

-52 kg

5 Judoka

	1	3	5	Wins	Scores
1 RENICKS, Louise GBR		+	+	2	(11)
3 ADA KARA, Christine GAB	-		+	1	(10)
5 YANG, Shuang CHN	-	-		0	(0)

	2	4	Wins	Scores
2 LEGENTIL, Christianne MRI		-	0	(0)
4 KEARNEY, Lisa IRL	+		1	(10)

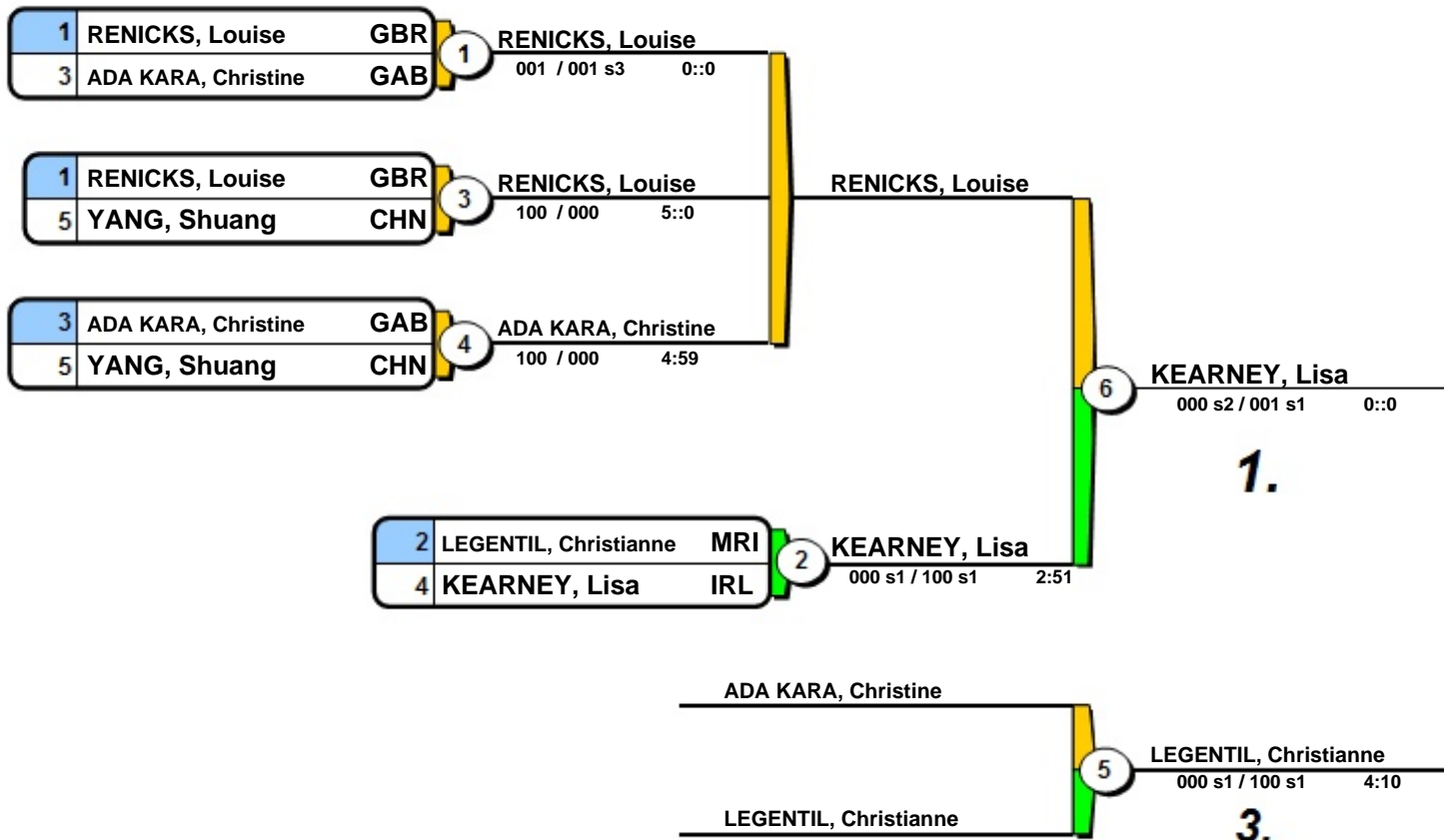

1. KEARNEY, Lisa IRL
2. RENICKS, Louise GBR
3. LEGENTIL, Christianne MRI



African Open Port Louis MRI 2013

Port Louis (MRI) 9-10 November 2013

-57 kg

6 Judoka

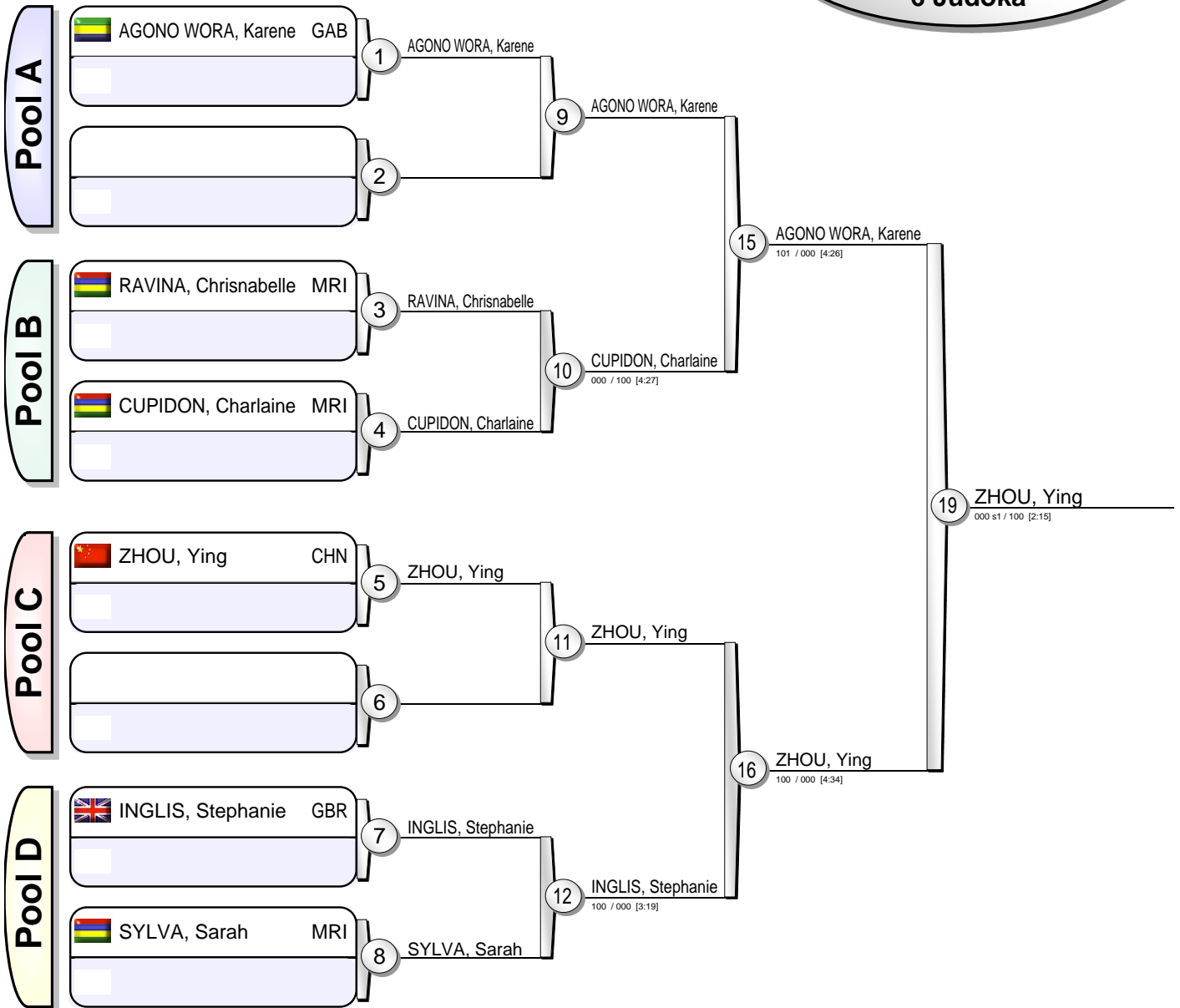

Results

1. ZHOU, Ying CHN
2. AGONO WORA, Karene GAB
3. INGLIS, Stephanie GBR
3. SYLVA, Sarah MRI
5. RAVINA, Chrisabelle MRI
5. CUPIDON, Charlaïne MRI
- 7.
- 7.





African Open Port Louis MRI 2013

Port Louis (MRI) 9-10 November 2013

-63 kg

8 Judoka

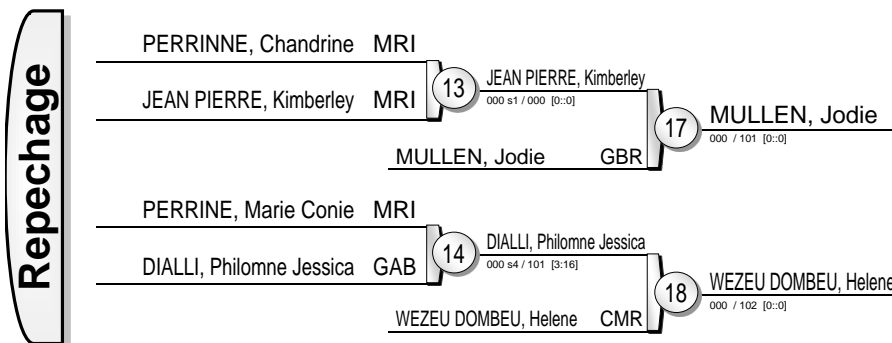

Results		
1.	AUGUSTINE, Esther	NGR
2.	YEATSBROWN, Katiejemima	GBR
3.	MULLEN, Jodie	GBR
3.	WEZEU DOMBEU, Helene	CMR
5.	JEAN PIERRE, Kimberley	MRI
5.	DIALLI, Philomne Jessica	GAB
7.	PERRINNE, Chandrine	MRI
7.	PERRINE, Marie Conie	MRI





African Open Port Louis MRI 2013

Port Louis (MRI) 9-10 November 2013

-70 kg

7 Judoka

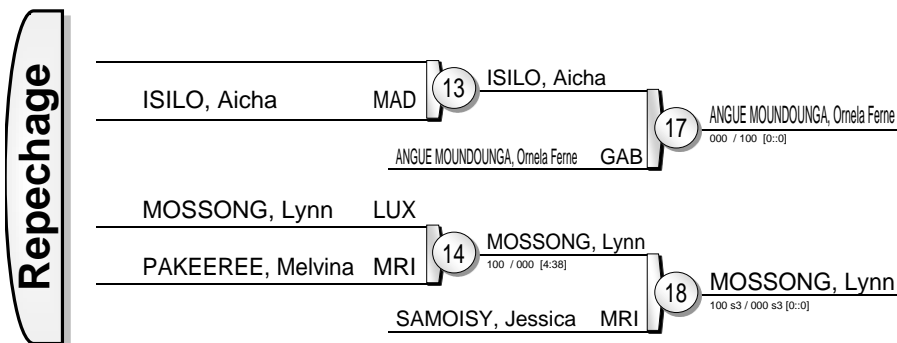
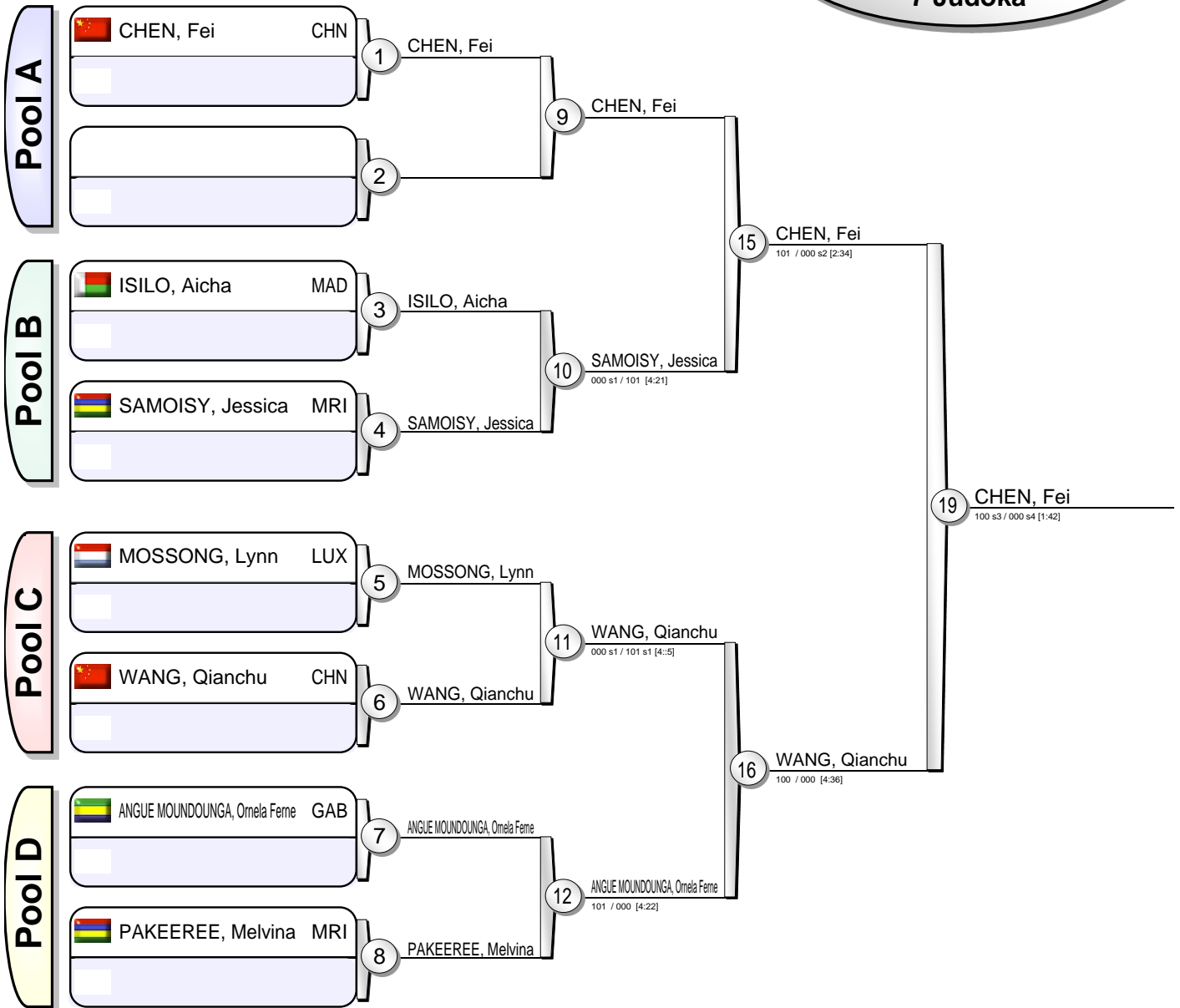

Results		
1.	CHEN, Fei	CHN
2.	WANG, Qianchu	CHN
3.	ANGUE MOUNDOUNGA, Ornela Ferne	GAB
3.	MOSSONG, Lynn	LUX
5.	ISILO, Aicha	MAD
5.	SAMOISY, Jessica	MRI
7.		
7.	PAKEEREE, Melvina	MRI





African Open Port Louis MRI 2013

Port Louis (MRI) 9-10 November 2013

-78 kg

3 Judoka

			1	2	3		
1	DING, Yuping	CHN		+	+	2 (20)	
2	ROSE, Brigitte	SEY	-		-	0 (0)	
3	MAZOUZ, Sarah Myriam	CAN	-	+		1 (10)	

1	DING, Yuping	CHN	1	DING, Yuping	CHN	111 / 000 s2	1:57
2	ROSE, Brigitte	SEY					

1	DING, Yuping	CHN	2	DING, Yuping	CHN	100 / 000	1:22
3	MAZOUZ, Sarah Myriam	CAN					

2	ROSE, Brigitte	SEY	3	MAZOUZ, Sarah Myriam	CAN	000 s1 / 100	2:34
3	MAZOUZ, Sarah Myriam	CAN					

1. DING, Yuping CHN
2. MAZOUZ, Sarah Myriam CAN



African Open Port Louis MRI 2013

Port Louis (MRI) 9-10 November 2013

+78 kg

4 Judoka

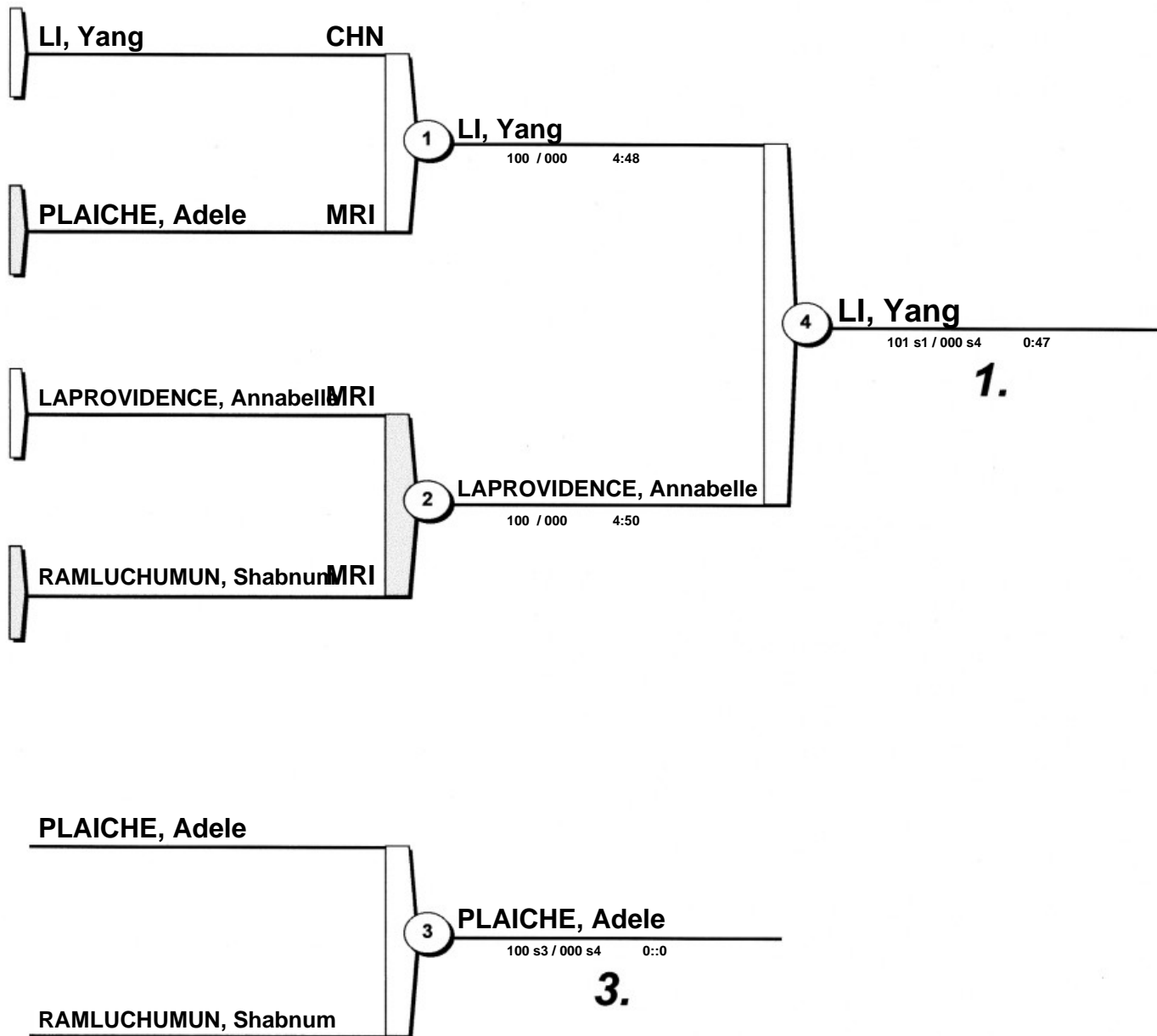

- 1. LI, Yang CHN
- 2. LAPROVIDENCE, Annabelle MRI
- 3. PLAICHE, Adele MRI