



IJF Grandprix Rotterdam 2010

(NED Rotterdam, 15-17 October 2010)

-60 kg

26 Judoka

Pool A

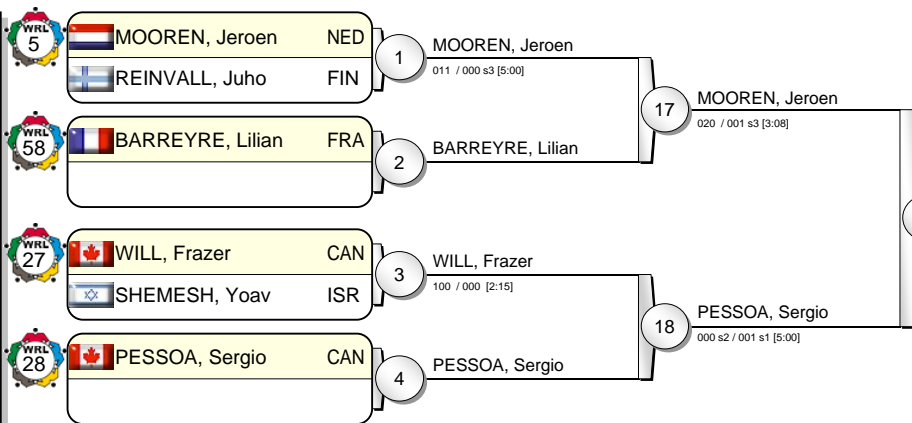

Pool B

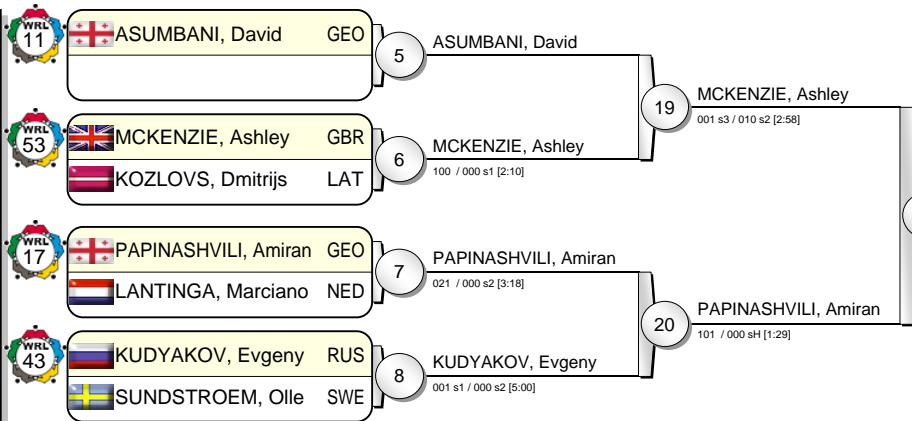

Pool C

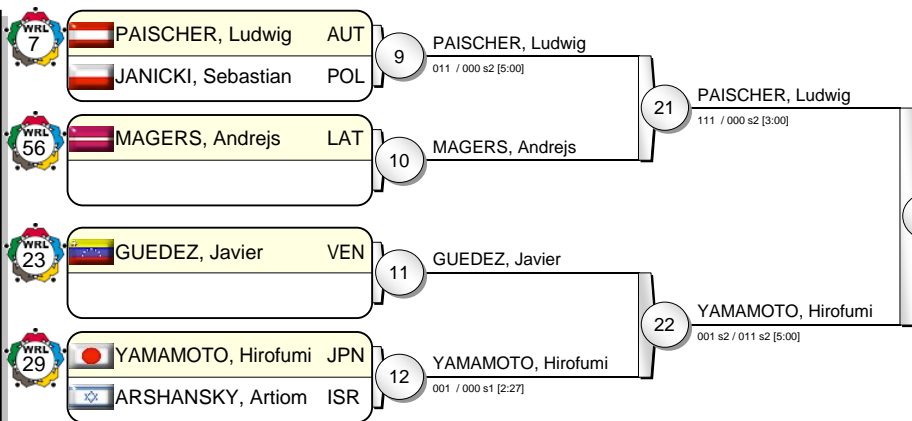

Pool D

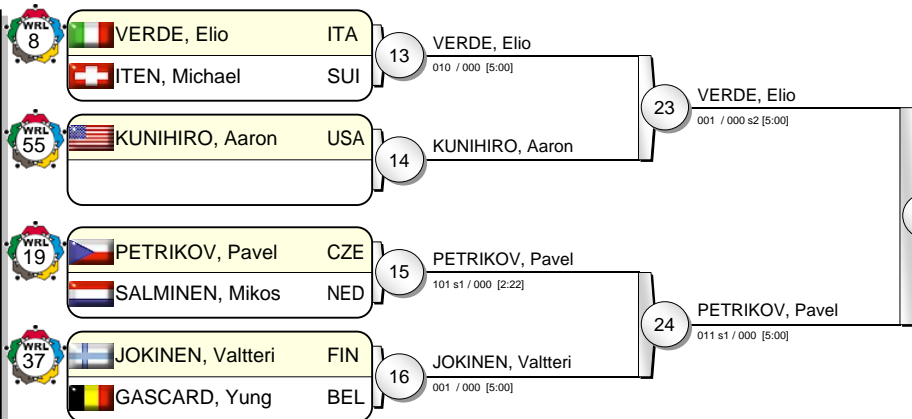

29 PAPANASHVILI, Amiran (GEO)

31 PAPANASHVILI, Amiran (GEO)

30 PAISCHER, Ludwig (AUT)

Results

1. PAPANASHVILI, Amiran (GEO)
2. PAISCHER, Ludwig (AUT)
3. PESSOA, Sergio (CAN)
3. VERDE, Elio (ITA)
5. MOOREN, Jeroen (NED)
5. MCKENZIE, Ashley (GBR)
5. YAMAMOTO, Hirofumi (JPN)
5. PETRIKOV, Pavel (CZE)





IJF Grandprix Rotterdam 2010

(NED Rotterdam, 15-17 October 2010)

-66 kg

26 Judoka

Pool A

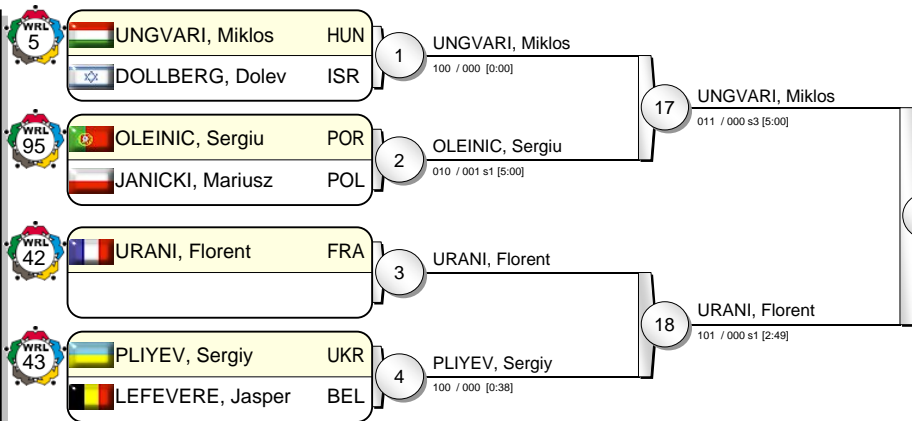

Pool B

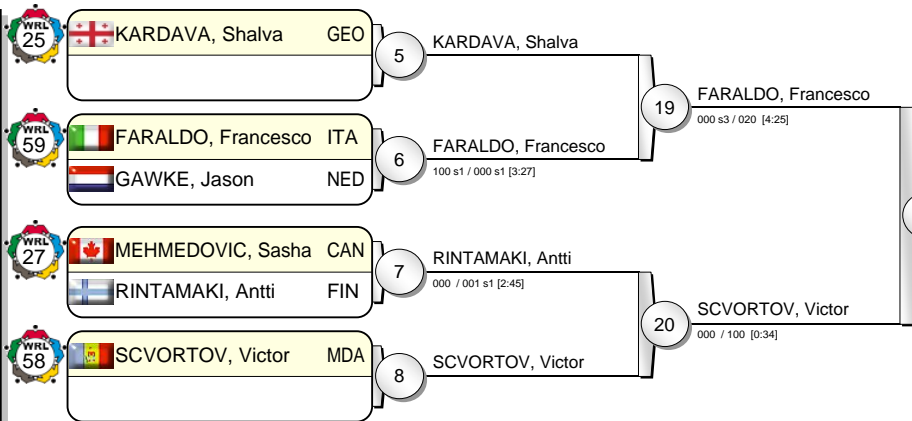

Pool C

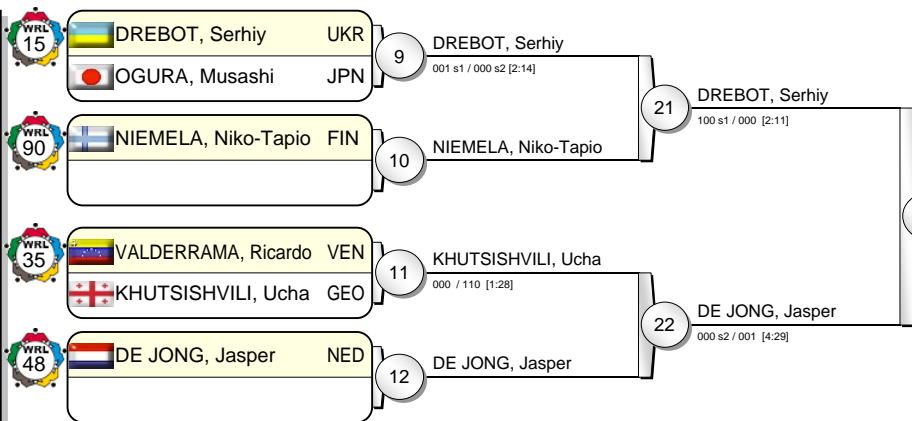

Pool D

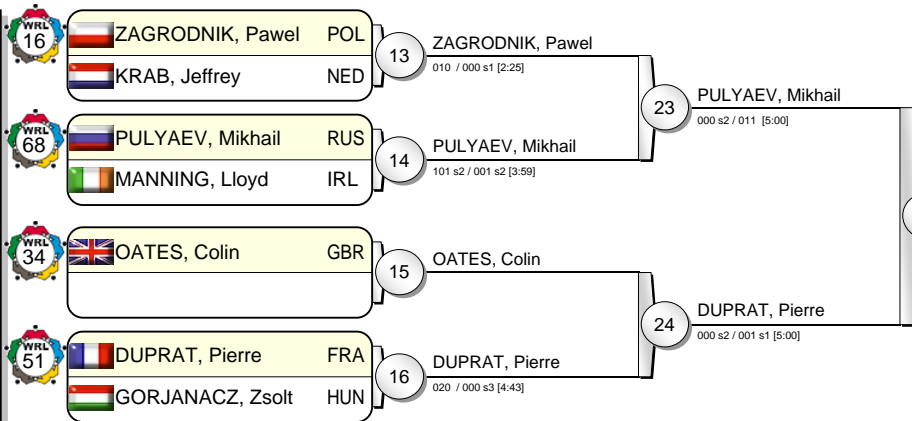

PULYAEV, Mikhail RUS 31
001 s2 / 002 s2 [5:00]

Results

- | | | | |
|----|--------------------|-----|--|
| 1. | PULYAEV, Mikhail | RUS | |
| 2. | FARALDO, Francesco | ITA | |
| 3. | UNGVARI, Miklos | HUN | |
| 3. | DREBOT, Serhiy | UKR | |
| 5. | URANI, Florent | FRA | |
| 5. | SCVORTOV, Victor | MDA | |
| 5. | DE JONG, Jasper | NED | |
| 5. | DUPRAT, Pierre | FRA | |





IJF Grandprix Rotterdam 2010

(NED Rotterdam, 15-17 October 2010)

-73 kg

32 Judoka

Pool A

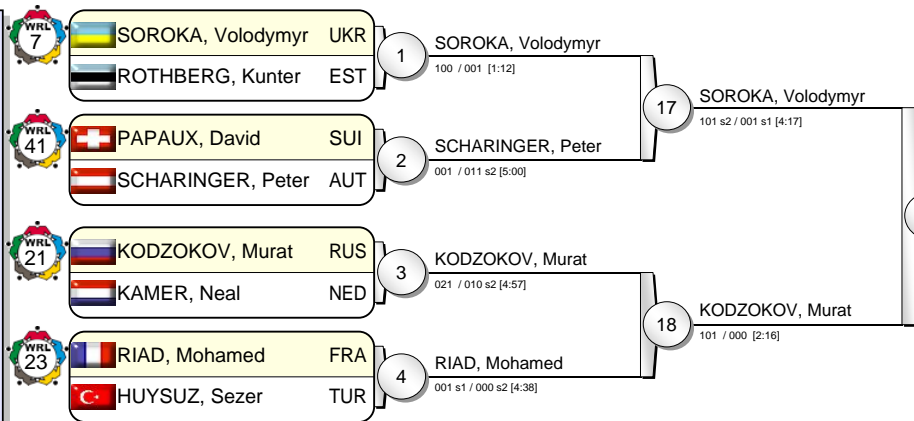

Pool B

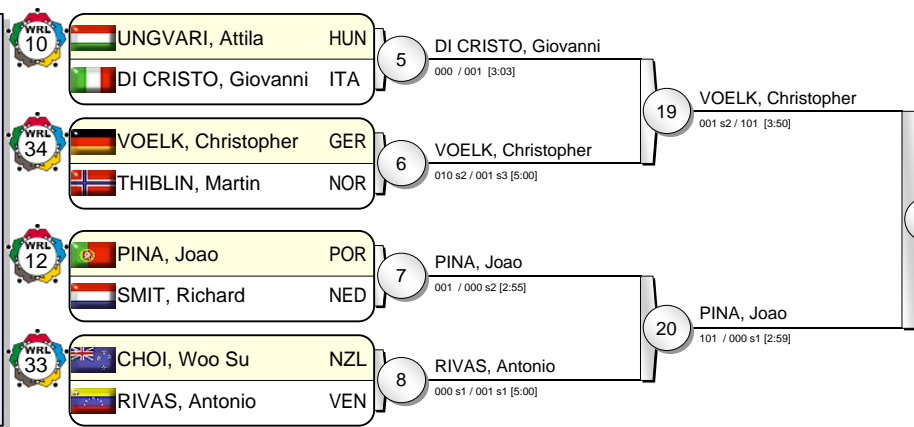

Pool C

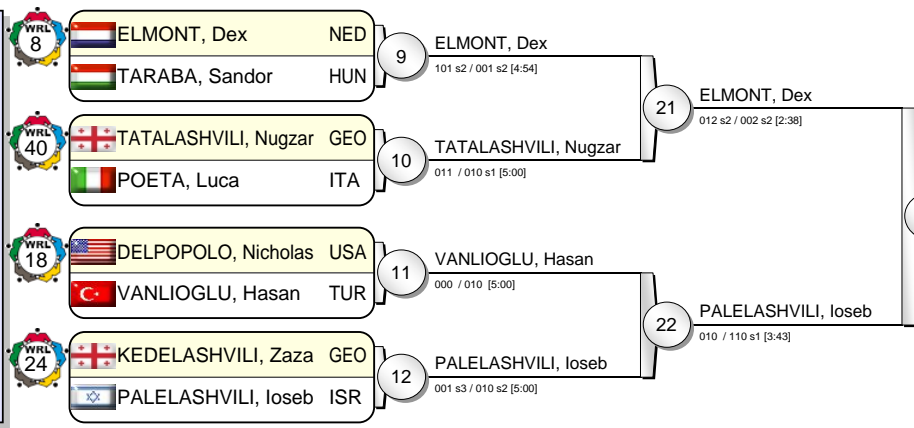

Pool D

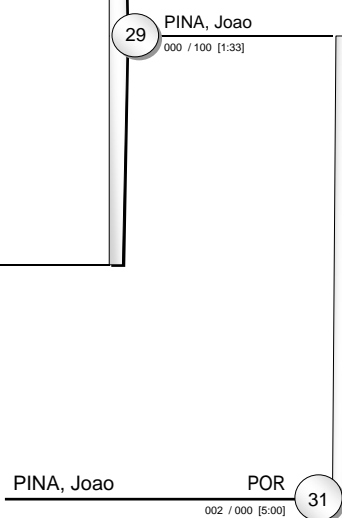
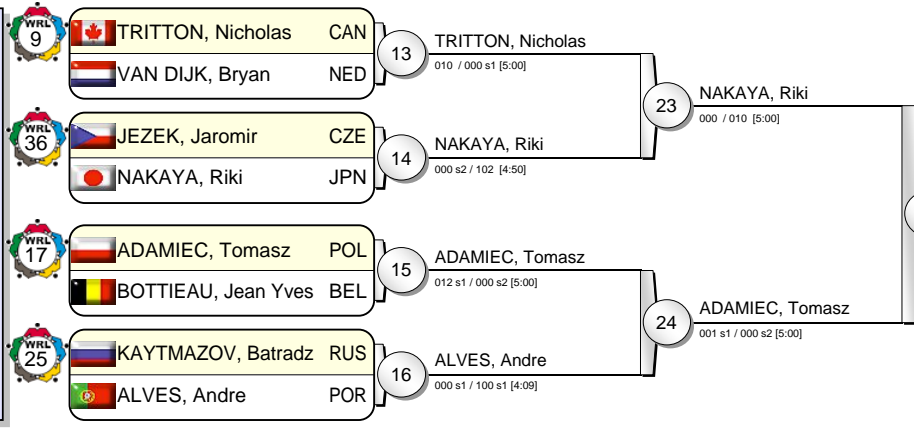

PINA, Joao POR 002 / 000 [5:00] 31

Results

- | | | |
|------------------------|-----|--|
| 1. PINA, Joao | POR | |
| 2. ELMONT, Dex | NED | |
| 3. KODZOKOV, Murat | RUS | |
| 3. ADAMIEC, Tomasz | POL | |
| 5. SOROKA, Volodymyr | UKR | |
| 5. VOELK, Christopher | GER | |
| 5. PALELASHVILI, Ioseb | ISR | |
| 5. NAKAYA, Riki | JPN | |





IJF Grandprix Rotterdam 2010

(NED Rotterdam, 15-17 October 2010)

-81 kg

38 Judoka

Pool A

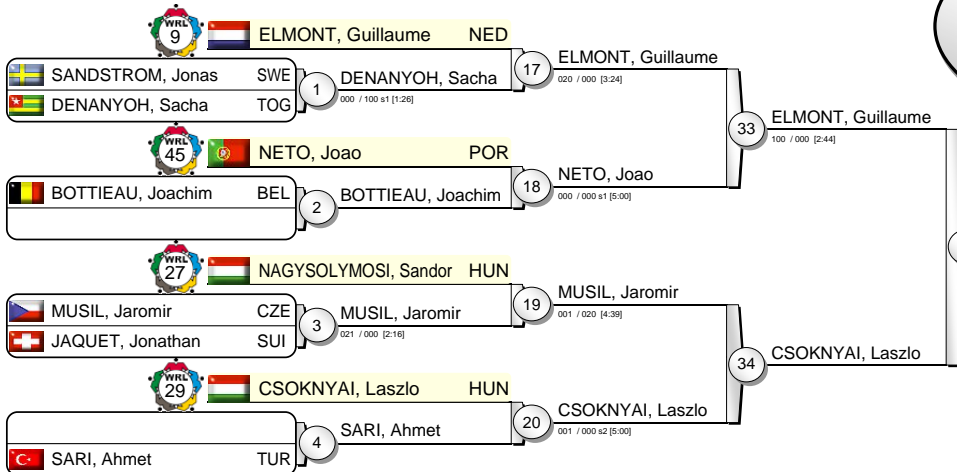

Pool B

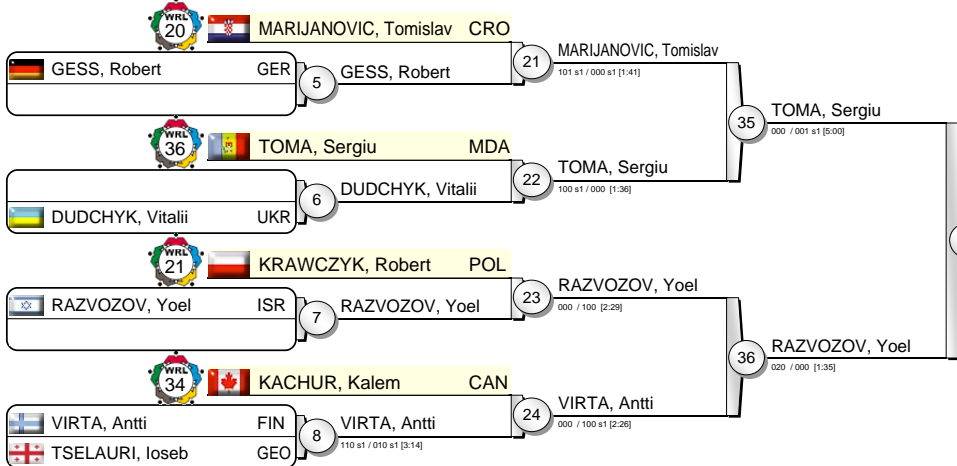

Pool C

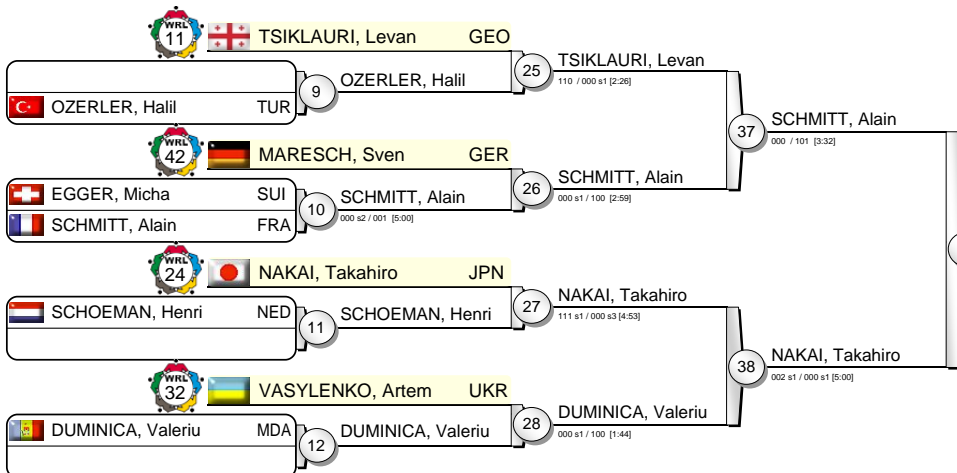

Pool D

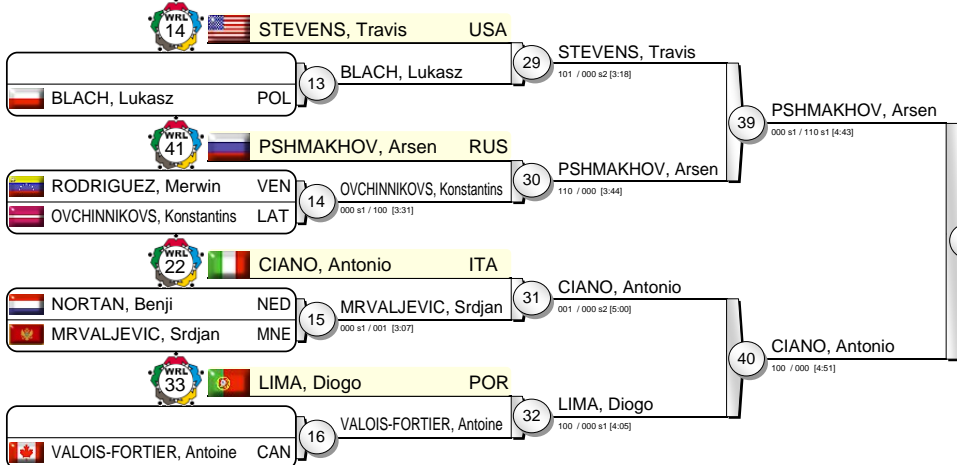

ELMONT, Guillaume (47)

100 / 000 [2:33]

NAKAI, Takahiro (46)

100 / 000 [4:25]

NAKAI, Takahiro (46)

100 / 000 [4:25]

Results

- ELMONT, Guillaume (NED)
- NAKAI, Takahiro (JPN)
- TOMA, Sergiu (MDA)
- CIANO, Antonio (ITA)
- CSOKNYAI, Laszlo (HUN)
- RAZVOZOV, Yoel (ISR)
- SCHMITT, Alain (FRA)
- PSHMAKHOV, Arsen (RUS)





IJF Grandprix Rotterdam 2010

(NED Rotterdam, 15-17 October 2010)

-90 kg

23 Judoka

Pool A

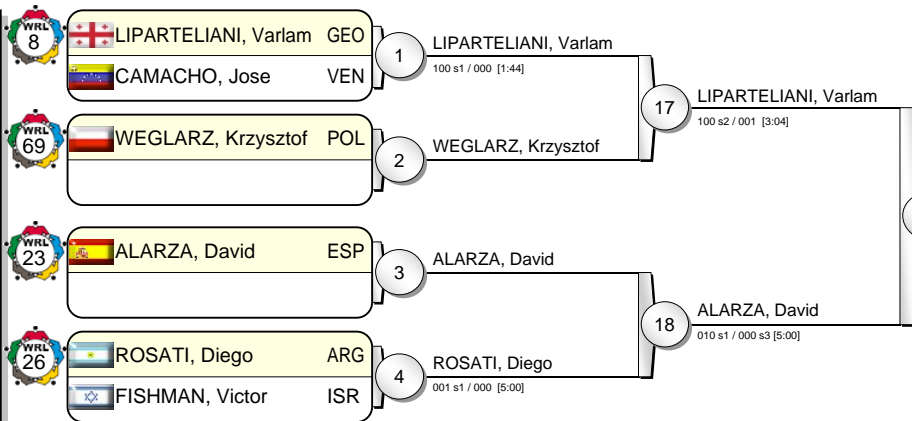

Pool B

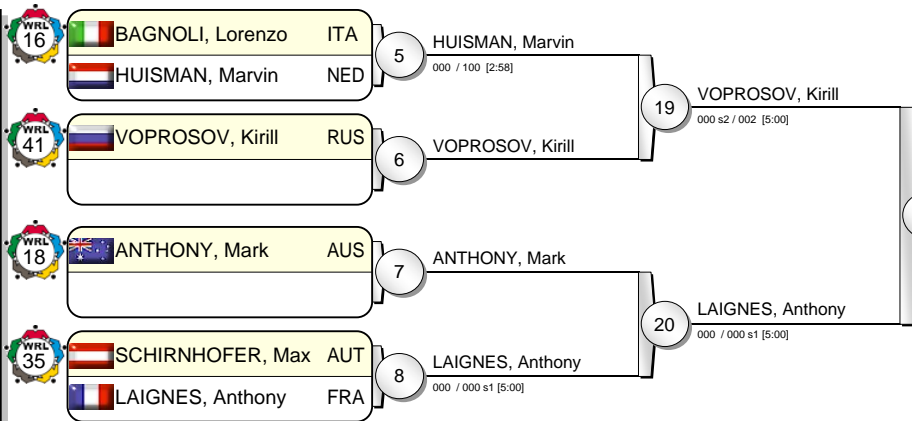

Pool C

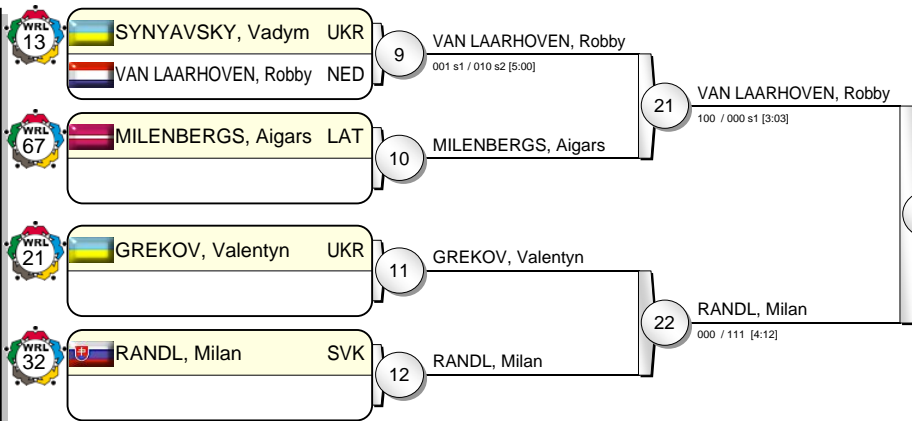

Pool D

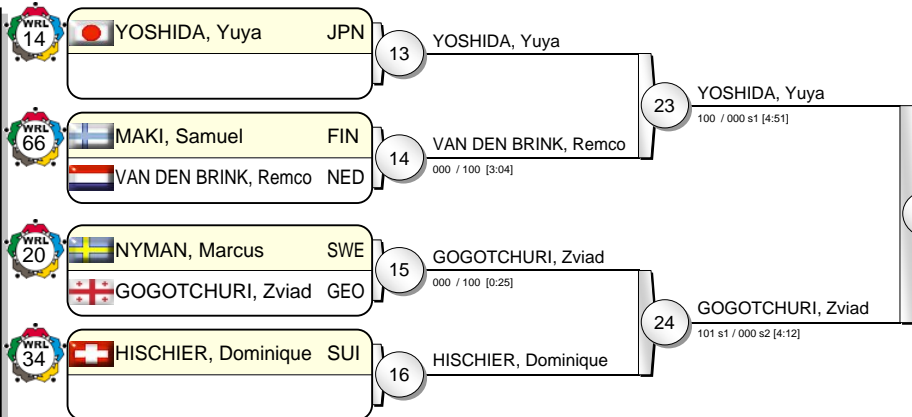

YOSHIDA, Yuya JPN 31

30 YOSHIDA, Yuya 000 / 100 [1:12]

Results

1.	YOSHIDA, Yuya	JPN	
2.	LIPARTELIANI, Varlam	GEO	
3.	VOPROSOV, Kirill	RUS	
3.	RANDL, Milan	SVK	
5.	ALARZA, David	ESP	
5.	LAIGNES, Anthony	FRA	
5.	VAN LAARHOVEN, Robby	NED	
5.	GOGOTCHURI, Zviad	GEO	





IJF Grandprix Rotterdam 2010

(NED Rotterdam, 15-17 October 2010)

-100 kg

13 Judoka

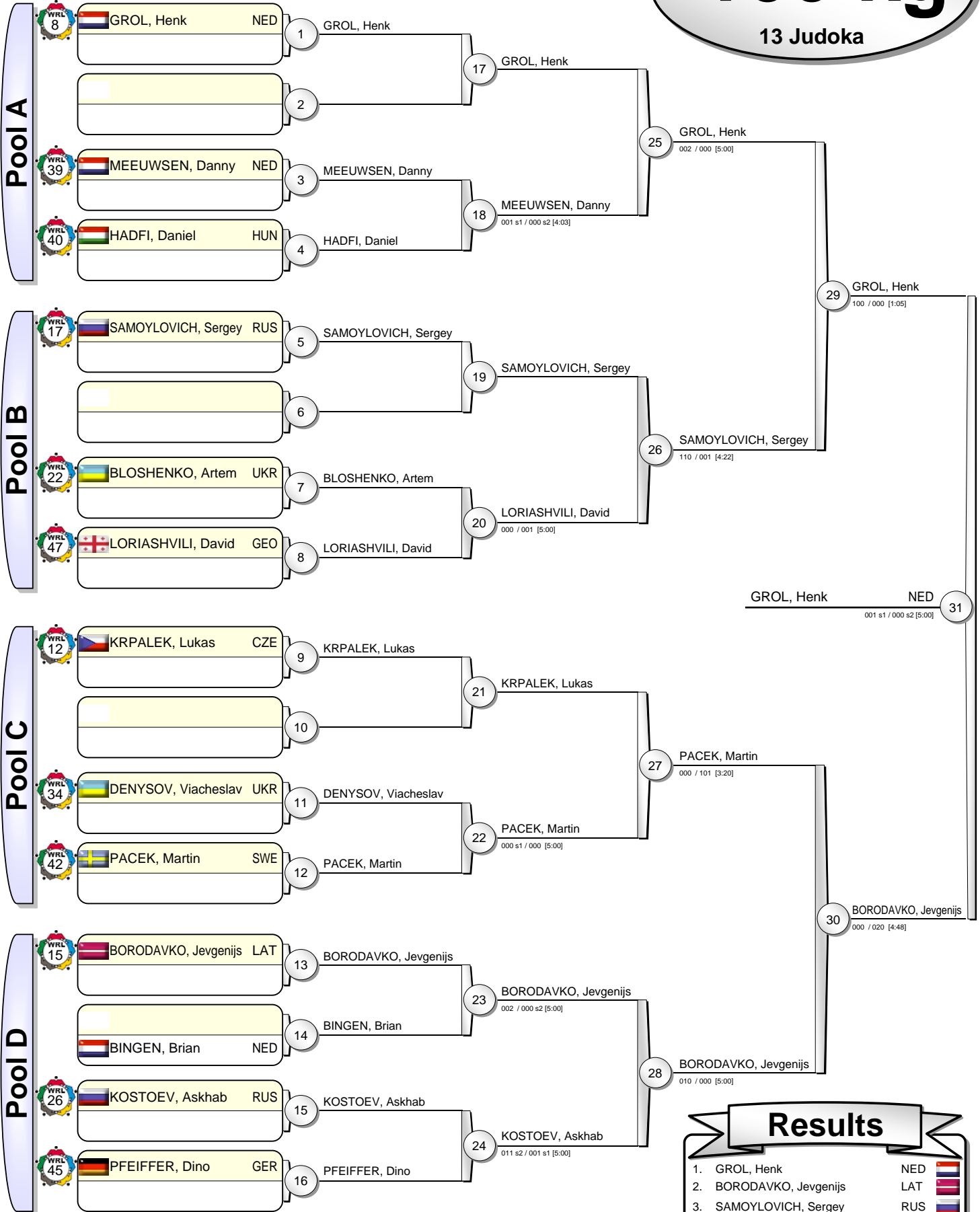

GROL, Henk NED 31
001 s1 / 000 s2 [5:00]

Results	
1. GROL, Henk	NED
2. BORODAVKO, Jevgenijs	LAT
3. SAMOYLOVICH, Sergey	RUS
3. PACEK, Martin	SWE
5. MEEUWSEN, Danny	NED
5. LORIASHVILI, David	GEO
5. KRPALEK, Lukas	CZE
5. KOSTOEV, Askhab	RUS



IJF Grandprix Rotterdam 2010

(NED Rotterdam, 15-17 October 2010)

+100 kg

12 Judoka

Pool A

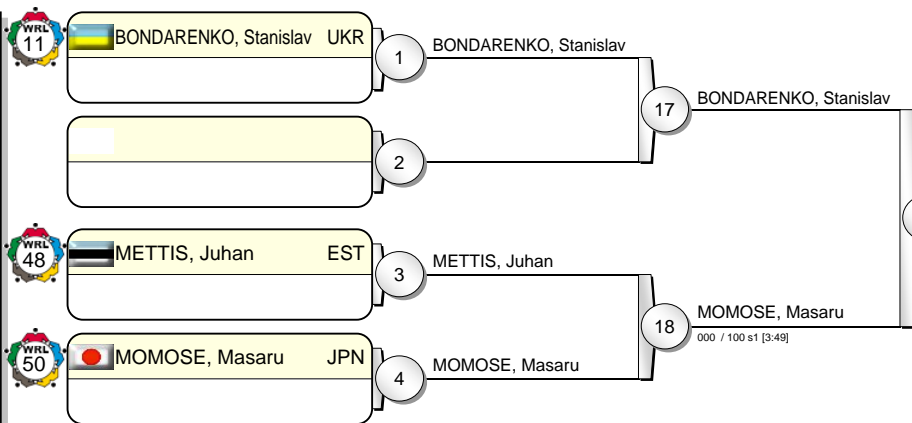

Pool B

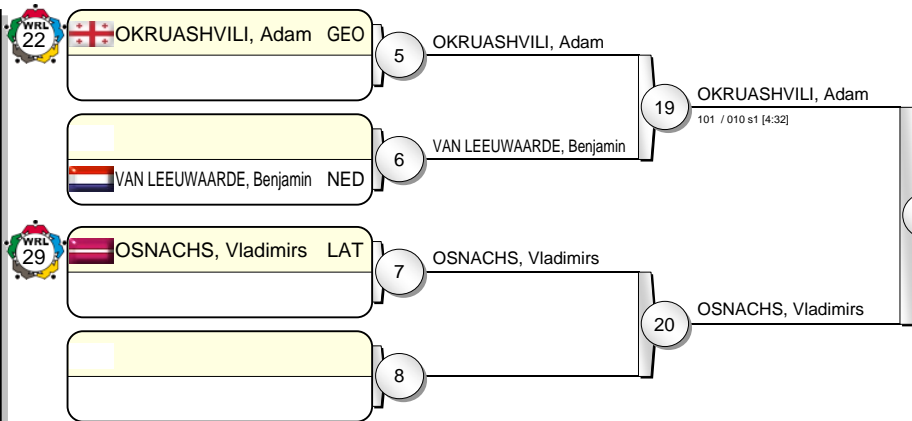

Pool C

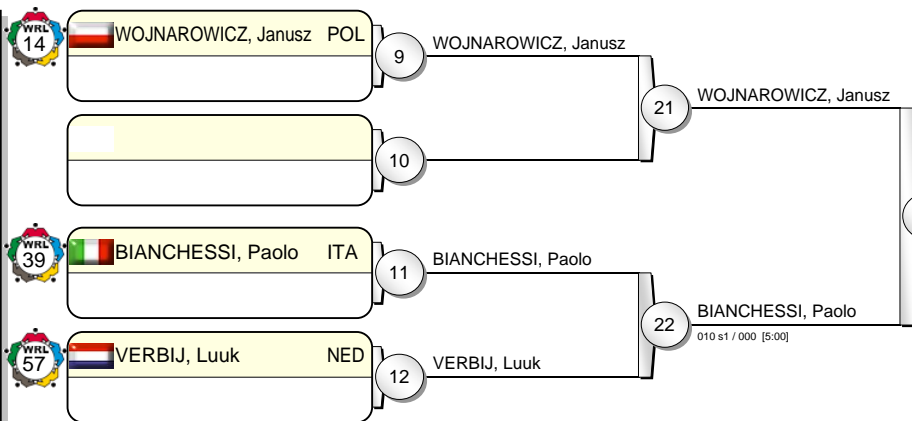

Pool D

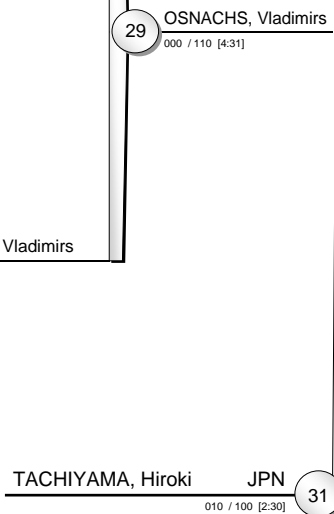
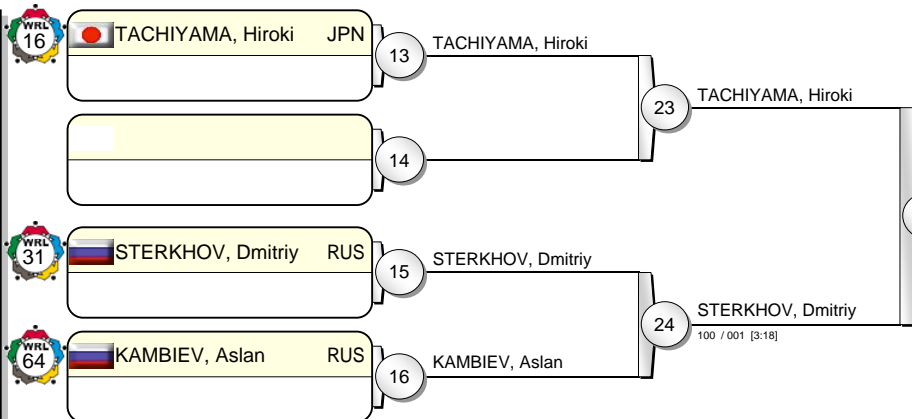

Results

- | | | |
|--------------------------|-----|--|
| 1. TACHIYAMA, Hiroki | JPN | |
| 2. OSNACHS, Vladimirs | LAT | |
| 3. BONDARENKO, Stanislav | UKR | |
| 3. BIANCHESSI, Paolo | ITA | |
| 5. MOMOSE, Masaru | JPN | |
| 5. OKRUASHVILI, Adam | GEO | |
| 5. WOJNAROWICZ, Janusz | POL | |
| 5. STERKHOV, Dmitry | RUS | |

