



IJF Grand Prix Tunis 2009

(TUN Tunis, 09-10 May 2009)

-48 kg

7 Judoka

Pool A

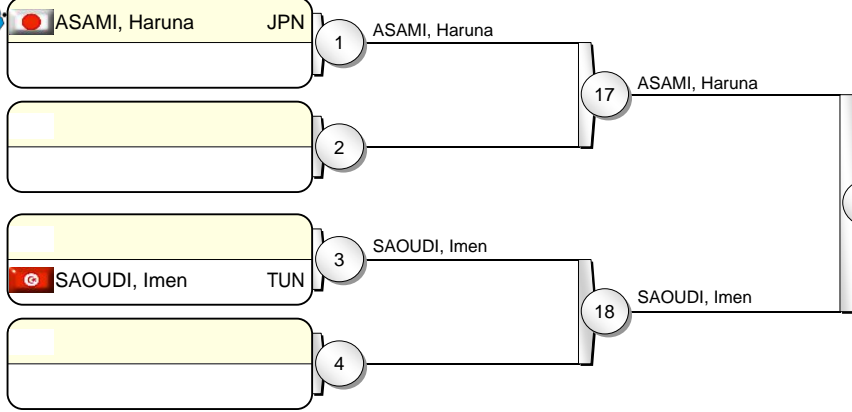

Pool B

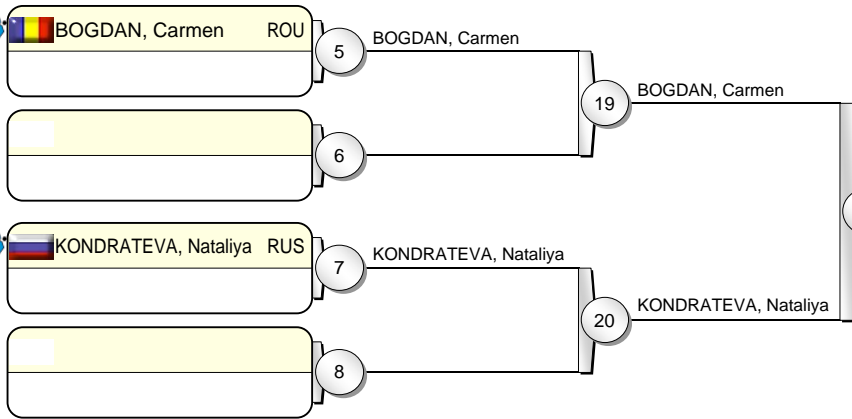

Pool C

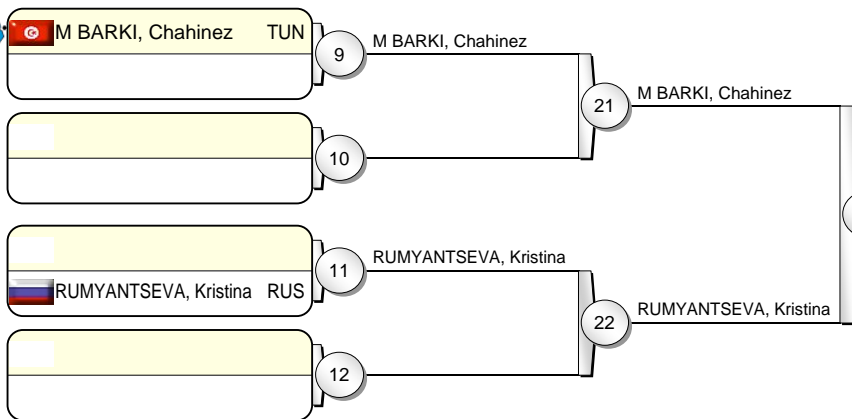

Pool D

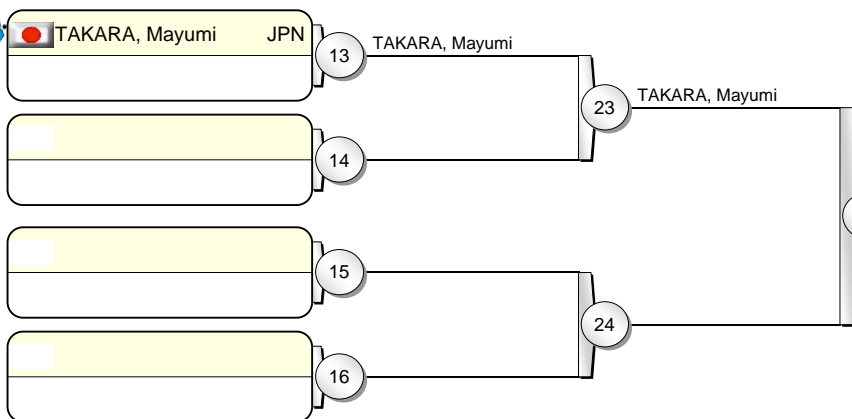

ASAMI, Haruna JPN 31 101 / 000 s1 [1:59]

M BARKI, Chahinez 30 010 s1 / 000 s3 [5:00]

Results

- | | | | |
|----|-----------------------|-----|--|
| 1. | ASAMI, Haruna | JPN | |
| 2. | M BARKI, Chahinez | TUN | |
| 3. | KONDRATEVA, Nataliya | RUS | |
| 3. | TAKARA, Mayumi | JPN | |
| 5. | SAOUDI, Imen | TUN | |
| 5. | BOGDAN, Carmen | ROU | |
| 5. | RUMYANTSEVA, Kristina | RUS | |
| 5. | | | |





IJF Grand Prix Tunis 2009

(TUN Tunis, 09-10 May 2009)

-52 kg

13 Judoka

Pool A

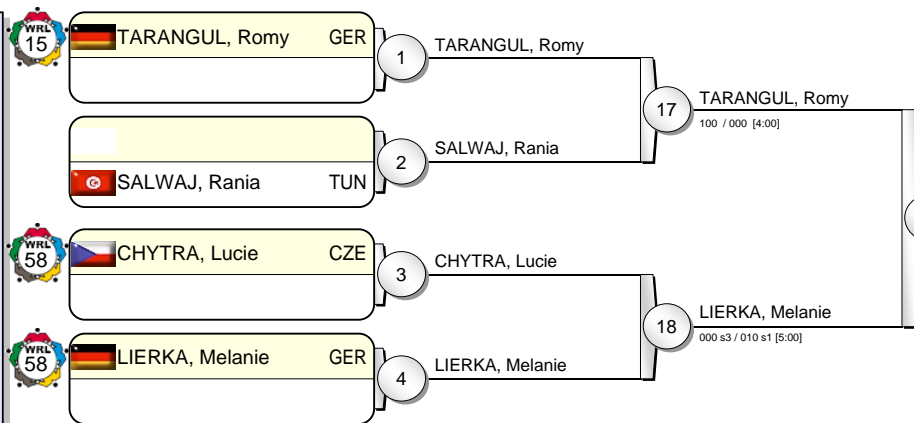

Pool B

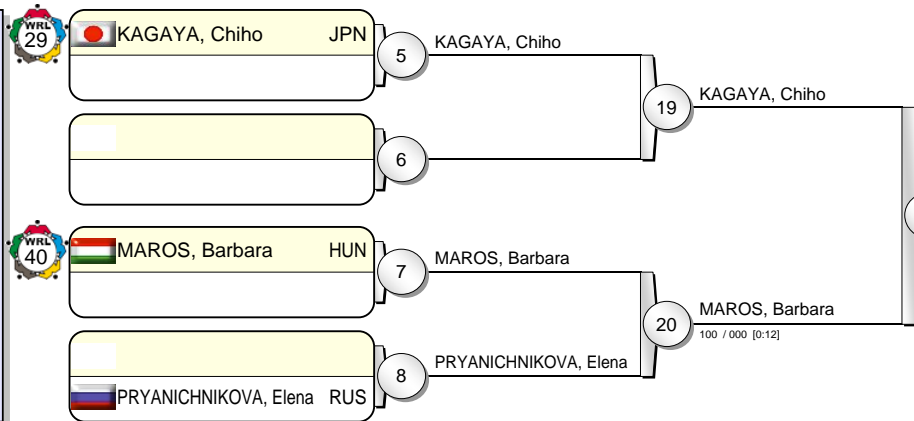

KAGAYA, Chiho JPN 31
100 s2 / 001 s1 [2:48]

Pool C

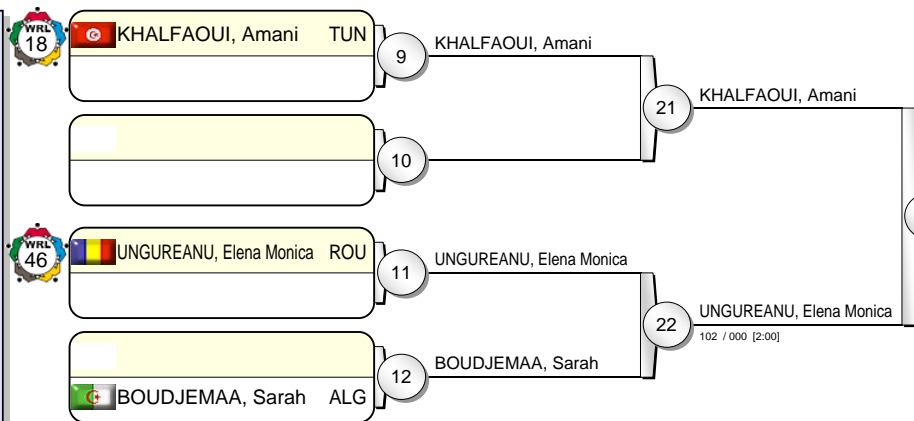

Pool D

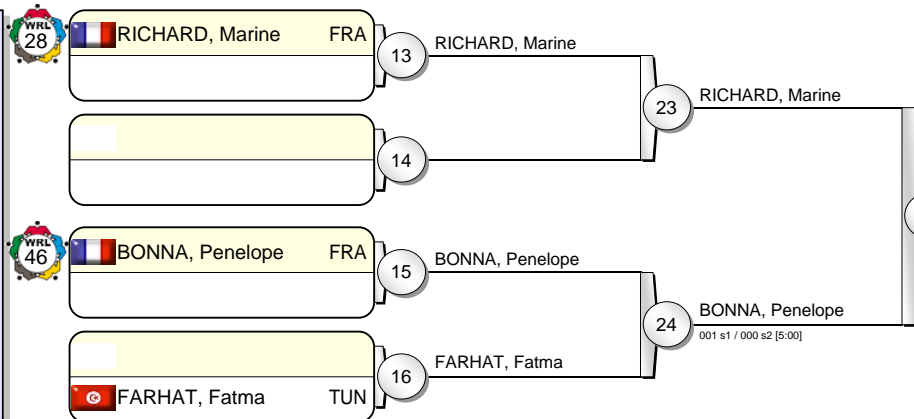

Results

- | | | |
|----------------------------|-----|--|
| 1. KAGAYA, Chiho | JPN | |
| 2. KHALFAOUI, Amani | TUN | |
| 3. TARANGUL, Romy | GER | |
| 3. RICHARD, Marine | FRA | |
| 5. LIERKA, Melanie | GER | |
| 5. MAROS, Barbara | HUN | |
| 5. UNGUREANU, Elena Monica | ROU | |
| 5. BONNA, Penelope | FRA | |





IJF Grand Prix Tunis 2009

(TUN Tunis, 09-10 May 2009)

-57 kg

17 Judoka

Pool A

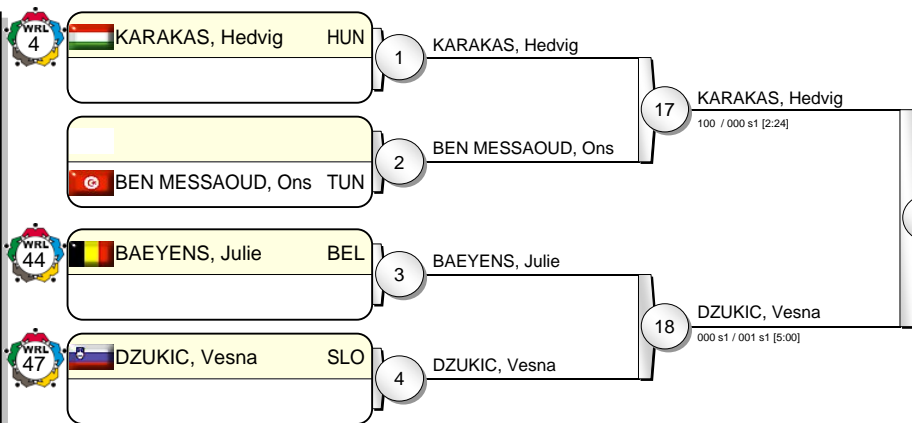

Pool B

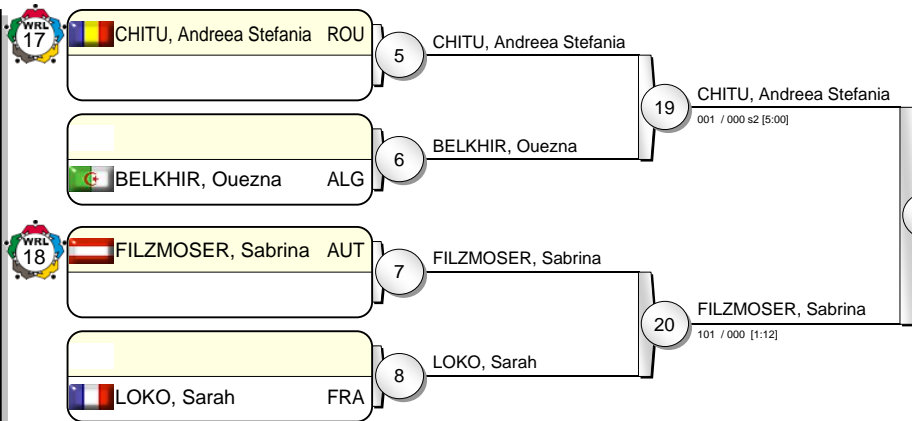

Pool C

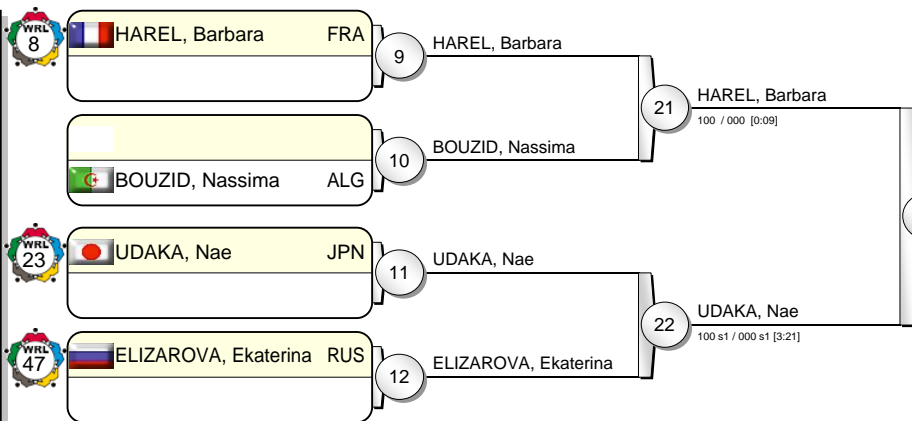

Pool D

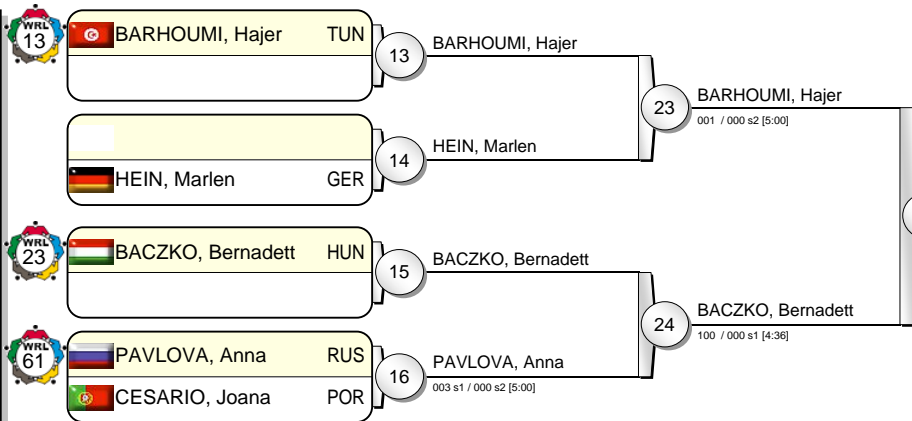

UDAKA, Nae JPN 31
000 s3 / 021 s1 [4:13]

UDAKA, Nae 27
000 / 001 [4:32]

UDAKA, Nae 30
103 / 000 s2 [4:51]

BACZKO, Bernadett 28
010 s1 / 021 s3 [4:56]

Results

- | | | |
|----------------------------|-----|--|
| 1. UDAKA, Nae | JPN | |
| 2. FILZMOSER, Sabrina | AUT | |
| 3. KARAKAS, Hedvig | HUN | |
| 3. BACZKO, Bernadett | HUN | |
| 5. DZUKIC, Vesna | SLO | |
| 5. CHITU, Andreea Stefania | ROU | |
| 5. HAREL, Barbara | FRA | |
| 5. BARHOUMI, Hajer | TUN | |





IJF Grand Prix Tunis 2009

(TUN Tunis, 09-10 May 2009)

-63 kg

11 Judoka

Pool A

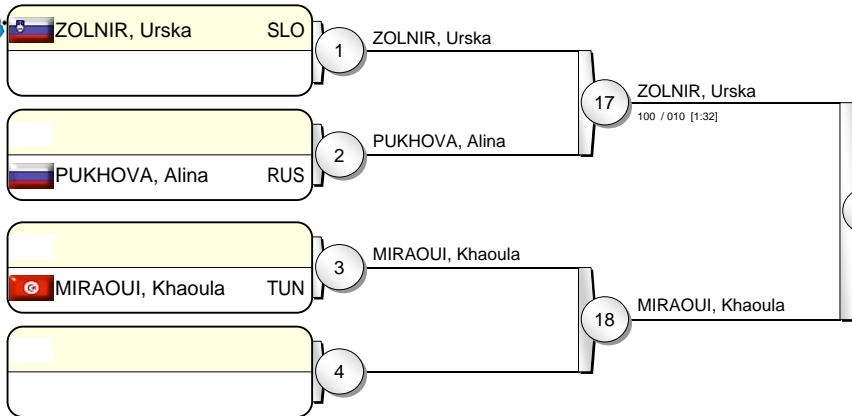

Pool B

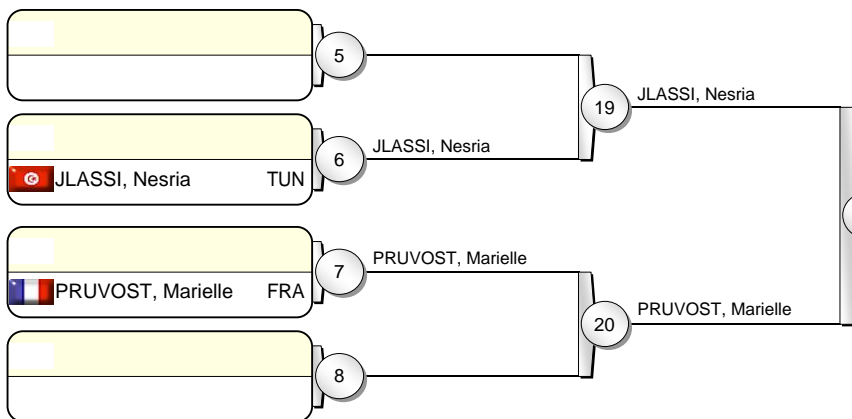

Pool C

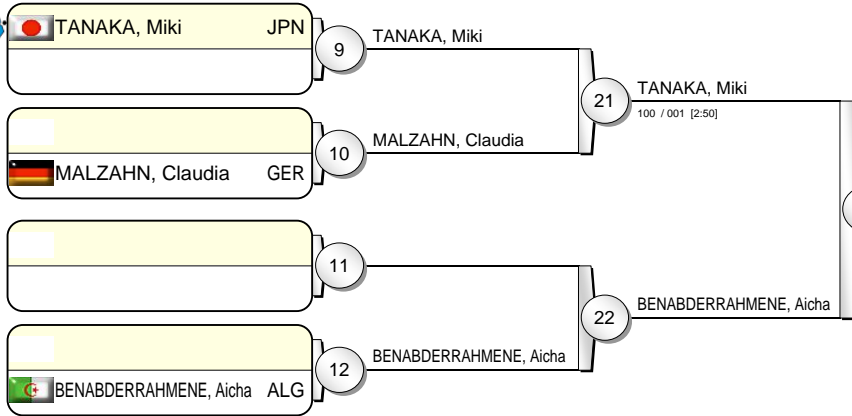

Pool D

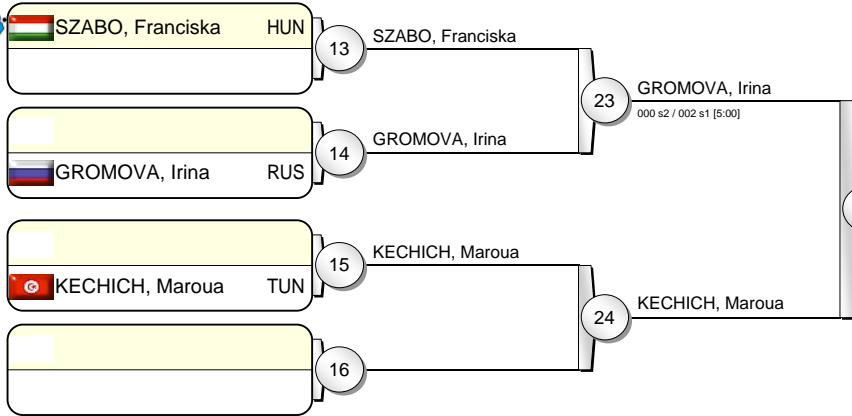

ZOLNIR, Urska SLO 31
111 / 000 s2 [2:34]

TANAKA, Miki 30
022 s1 / 000 s2 [4:49]

Results

- | | | |
|---------------------------|-----|--|
| 1. ZOLNIR, Urska | SLO | |
| 2. TANAKA, Miki | JPN | |
| 3. PRUVOST, Marielle | FRA | |
| 3. GROMOVA, Irina | RUS | |
| 5. MIRAOU, Khaoula | TUN | |
| 5. Jlassi, Nesria | TUN | |
| 5. BENABDERRAHMENE, Aicha | ALG | |
| 5. KECHICH, Maroua | TUN | |





IJF Grand Prix Tunis 2009

(TUN Tunis, 09-10 May 2009)

-70 kg

11 Judoka

Pool A

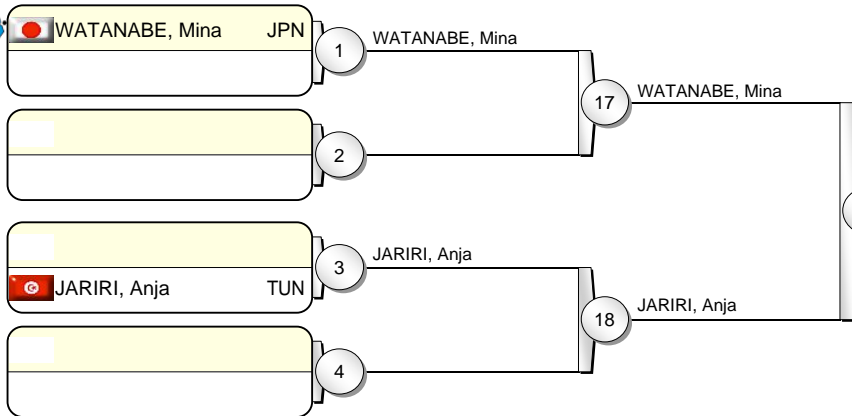

Pool B

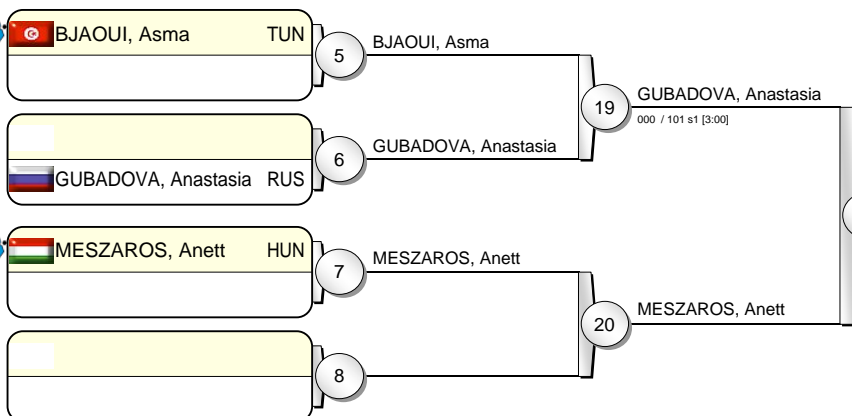

Pool C

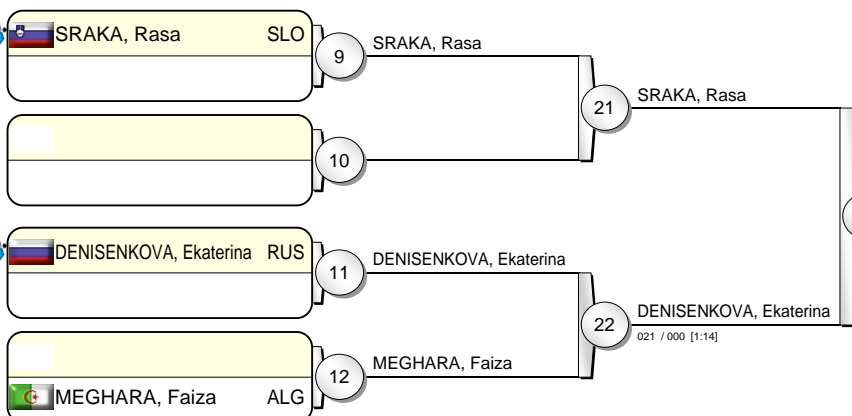

Pool D

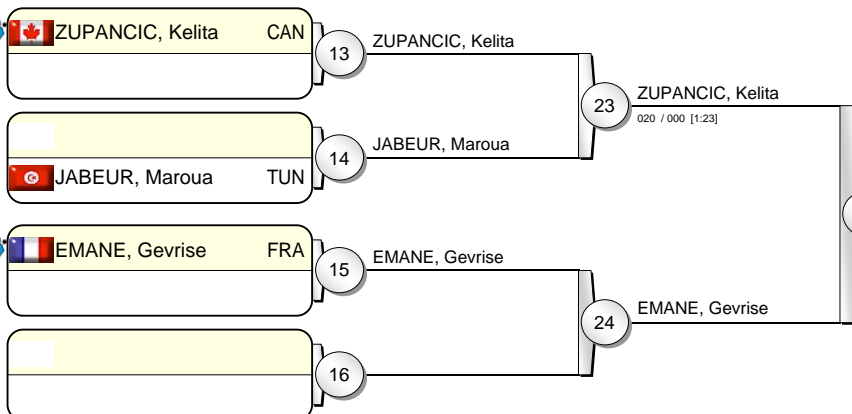

Sraka, Rasa (SLO) [31] 001 / 010 [5:00]

Results

- | | | |
|---------------------------|-----|--|
| 1. SRAKA, Rasa | SLO | |
| 2. MESZAROS, Anett | HUN | |
| 3. WATANABE, Mina | JPN | |
| 3. EMANE, Gevrise | FRA | |
| 5. JARIRI, Anja | TUN | |
| 5. GUBADOVA, Anastasia | RUS | |
| 5. DENISENKOVA, Ekaterina | RUS | |
| 5. ZUPANCIC, Kelita | CAN | |





IJF Grand Prix Tunis 2009

(TUN Tunis, 09-10 May 2009)

-78 kg

10 Judoka

Pool A

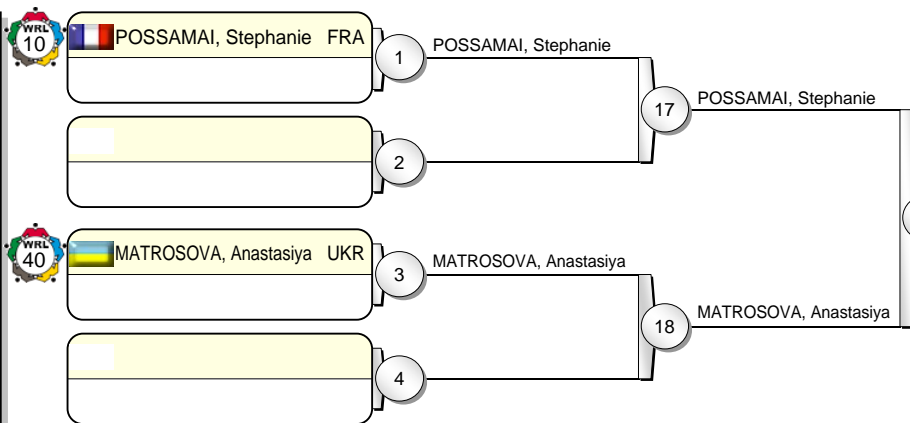

Pool B

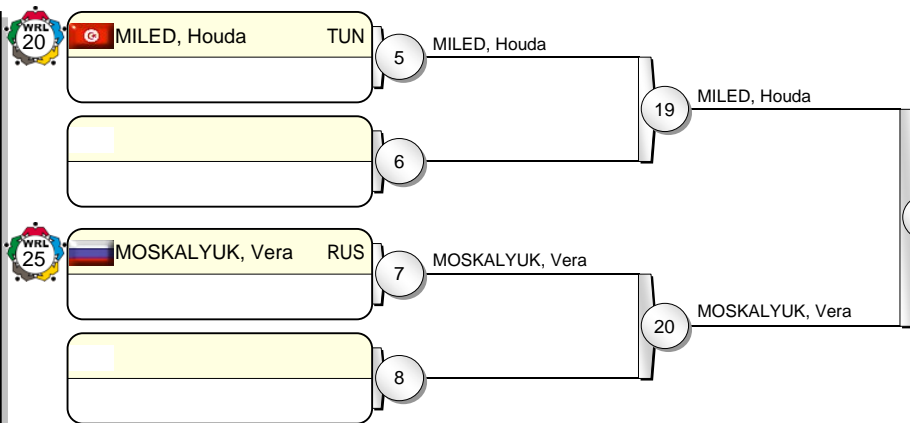

Pool C

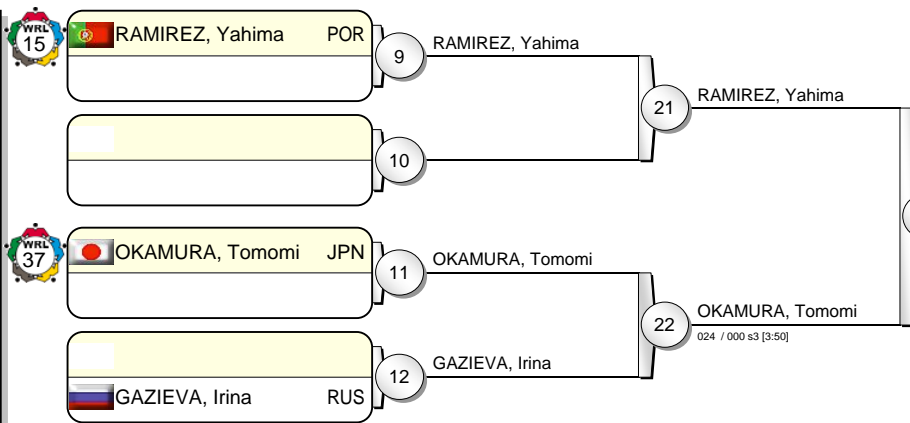

Pool D

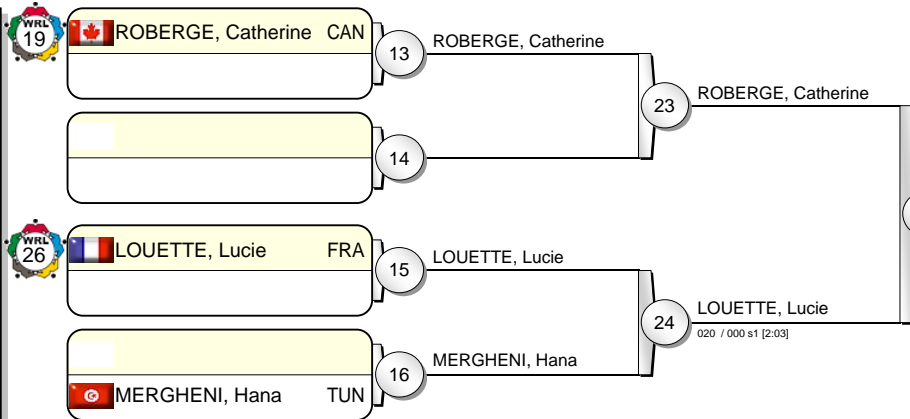

29 MOSKALYUK, Vera
000 / 001 [3:50]

MOSKALYUK, Vera RUS 31
011 / 000 [5:00]

30 OKAMURA, Tomomi
110 / 000 [2:17]

Results

- | | | |
|--------------------------|-----|--|
| 1. MOSKALYUK, Vera | RUS | |
| 2. OKAMURA, Tomomi | JPN | |
| 3. MATROSOVA, Anastasiya | UKR | |
| 3. ROBERGE, Catherine | CAN | |
| 5. POSSAMAI, Stephanie | FRA | |
| 5. MILED, Houda | TUN | |
| 5. RAMIREZ, Yahima | POR | |
| 5. LOUETTE, Lucie | FRA | |





IJF Grand Prix Tunis 2009

(TUN Tunis, 09-10 May 2009)

+78 kg

5 Judoka

			1	3	5		
1	CHIKHROUHOU, Nihel	TUN		+	-	1 (5)	
3	DONGUZASHVILI, Tea	RUS	-		+	1 (7)	
5	PROKOFYEVA, Maryna	UKR	+	-		1 (10)	

			2	4		
2	POLAVDER, Lucija	SLO		+		
4	ASSELAH, Sabrina	ALG	-			

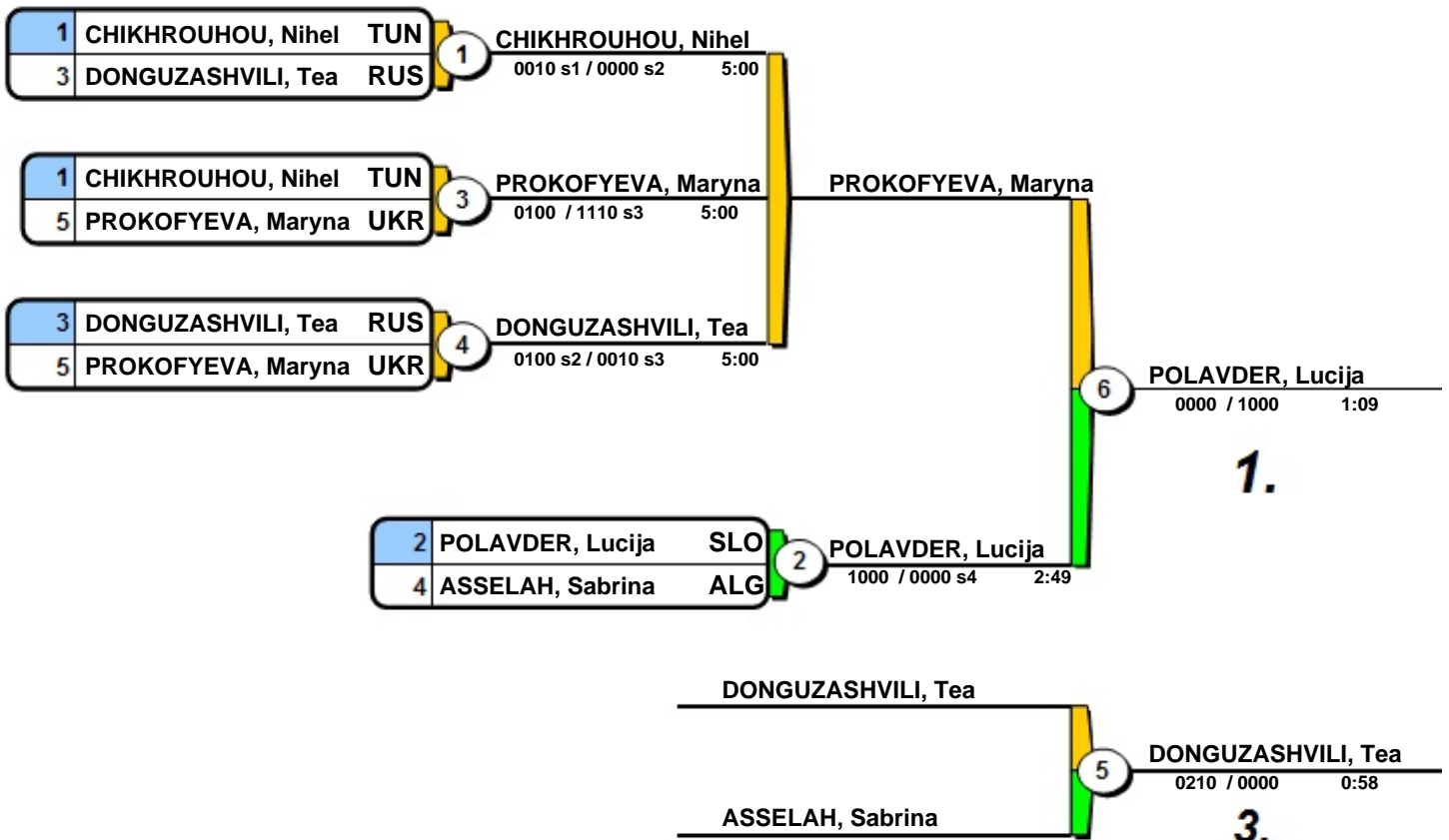

Final Results

- . POLAVDER, Lucija SLO
- . PROKOFYEVA, Maryna UKR
- . DONGUZASHVILI, Tea RUS