



World Cup Samoa 2009

(SAM Apia, 13-14 Nov 2009)

-60 kg

8 Judoka

Pool A

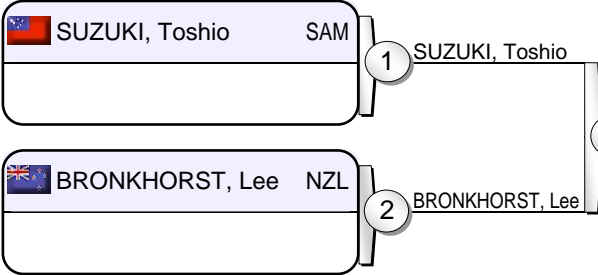

Pool B

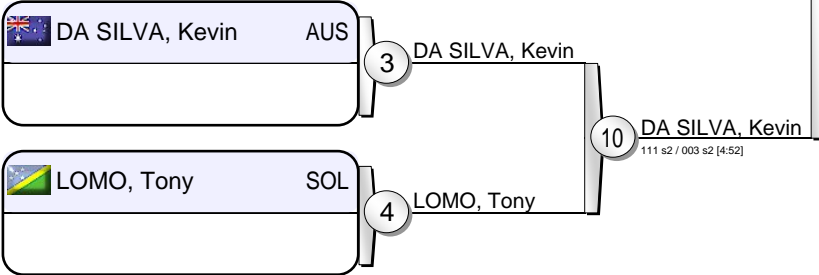

Pool C

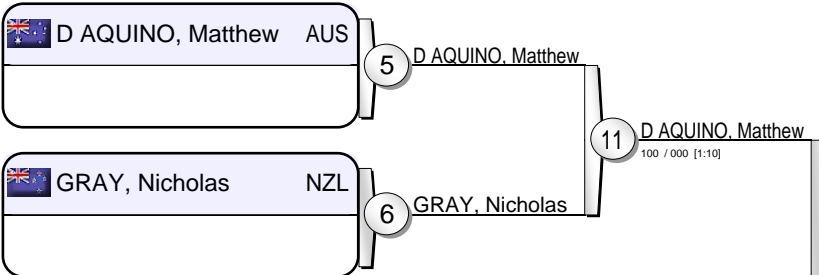

Pool D

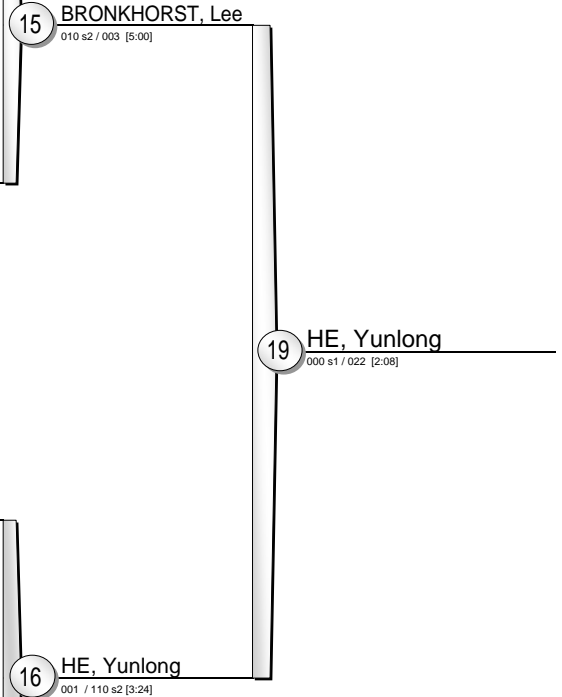
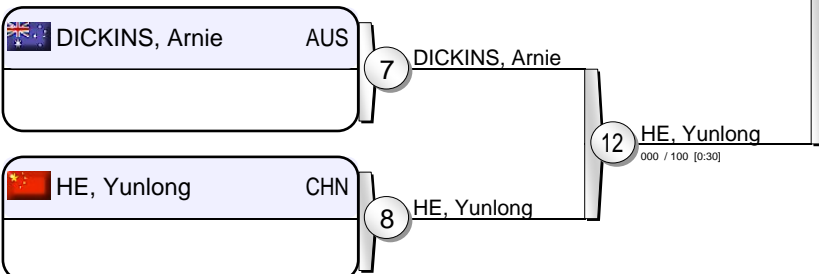

Repechage

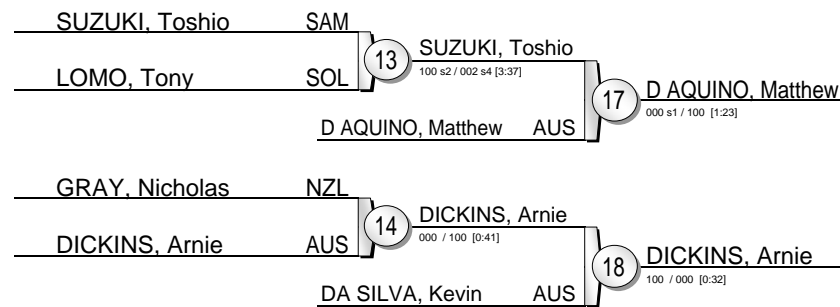

Results

1. HE, Yunlong CHN
2. BRONKHORST, Lee NZL
3. D AQUINO, Matthew AUS
3. DICKINS, Arnie AUS
5. SUZUKI, Toshio SAM
5. DA SILVA, Kevin AUS
7. LOMO, Tony SOL
7. GRAY, Nicholas NZL





World Cup Samoa 2009

(SAM Apia, 13-14 Nov 2009)

-66 kg

13 Judoka

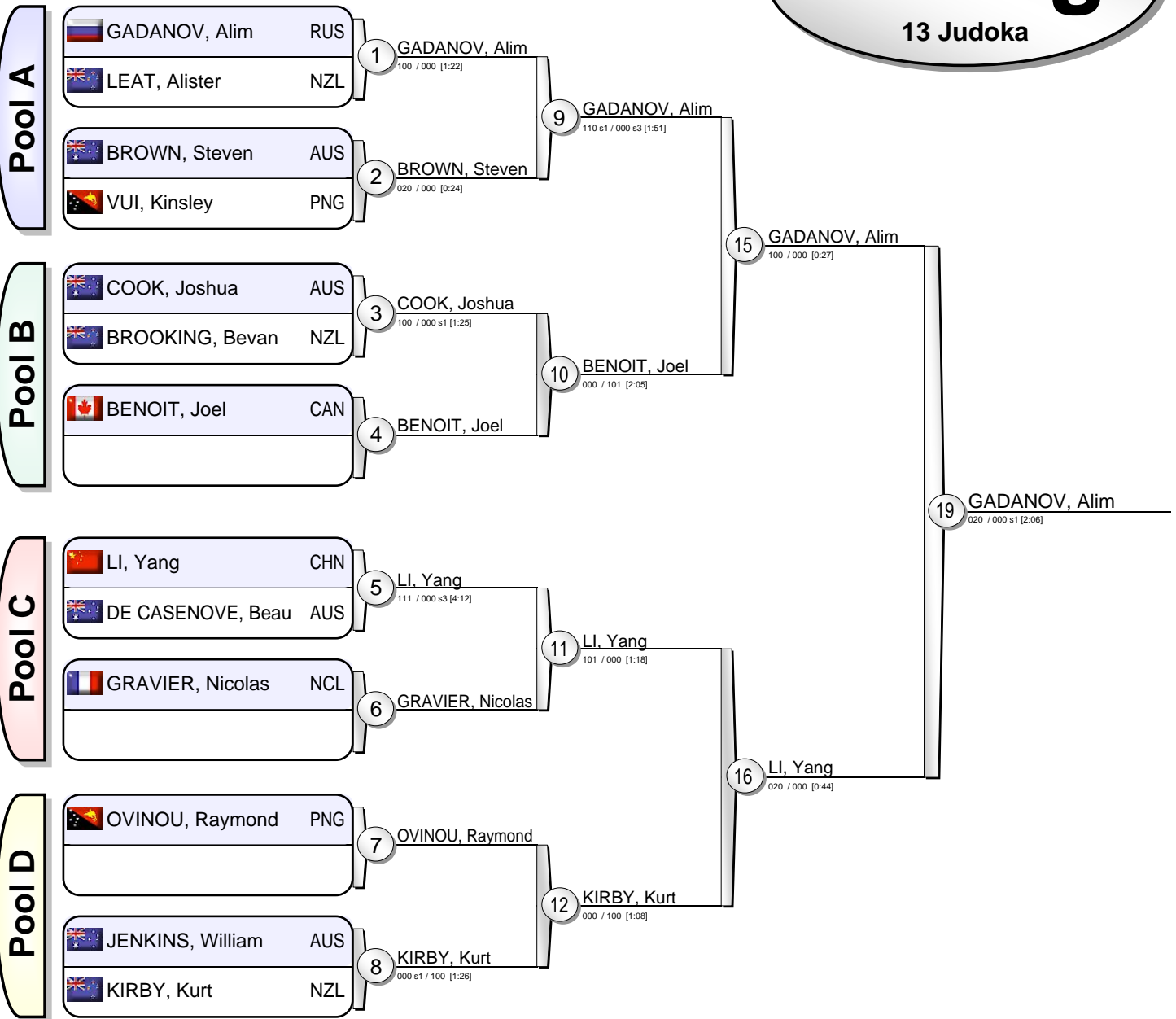

Results

- GADANOV, Alim (RUS)
- LI, Yang (CHN)
- BROWN, Steven (AUS)
- BENOIT, Joel (CAN)
- KIRBY, Kurt (NZL)
- GRAVIER, Nicolas (NCL)
- COOK, Joshua (AUS)
- OVINO, Raymond (PNG)





World Cup Samoa 2009

(SAM Apia, 13-14 Nov 2009)

-73 kg

17 Judoka

Pool A

	ISAEV, Mansur	RUS	1	ISAEV, Mansur	17	ISAEV, Mansur	100 / 000 sH [2:21]
	PEJIC, Nikola	AUS	2	PEJIC, Nikola			
	CALDER, Lee	NZL	3	CALDER, Lee	18	CALDER, Lee	100 / 000 s1 [0:43]
	JIMWEREIJ, Maruan	NAU	4	JIMWEREIJ, Maruan			

25 CALDER, Lee
003 sH / 110 s2 [4:52]

31 ZENG, Qingdong
001 s1 / 100 s2 [2:03]

Pool B

	IVERSON, Dennis	AUS	5	IVERSON, Dennis	19	CHOI, Sean	000 s2 / 102 [2:54]
	CHOI, Sean	NZL	6	CHOI, Sean			
	SMITH, Aleni	SAM	7	SMITH, Aleni	20	ZENG, Qingdong	000 / 100 [0:28]
	ZENG, Qingdong	CHN	8	ZENG, Qingdong			

26 ZENG, Qingdong
001 s1 / 100 s2 [3:11]

35 NARTEY, Emmanuel
001 s1 / 100 s2 [4:28]

Pool C

	NARTEY, Emmanuel	GHA	9	NARTEY, Emmanuel	21	NARTEY, Emmanuel	100 / 000 [0:50]
	DULAC, Paul	NCL	10	DULAC, Paul			
	CARLYON, Addison	AUS	11	CARLYON, Addison	22	LEAT, Adrian	000 s2 / 001 [5:00]
	LEAT, Adrian	NZL	12	LEAT, Adrian			

27 NARTEY, Emmanuel
111 s2 / 001 s1 [3:47]

32 NARTEY, Emmanuel
113 s2 / 001 [4:10]

Pool D

	AUBIN-MERCIER, Olivier	CAN	13	AUBIN-MERCIER, Olivier	23	AUBIN-MERCIER, Olivier	110 s2 / 001 s1 [4:30]
	McINTOSH, David	AUS	14	McINTOSH, David			
	WATERHOUSE, Hycenthe	SAM	14	WATERHOUSE, Hycenthe	110 / 000 [0:10]		
	ELDRED, Michael	USA	15	ELDRED, Michael	24	ELDRED, Michael	020 s1 / 000 s1 [3:51]
	RAGECI, Pelasio	FIJ	16	RAGECI, Pelasio			

28 AUBIN-MERCIER, Olivier
100 s1 / 000 s1 [2:41]

Repechage

ISAEV, Mansur	RUS	29	ISAEV, Mansur	101 s3 / 010 s2 [3:47]	33	ISAEV, Mansur	100 / 001 s1 [2:40]
CHOI, Sean	NZL						
						AUBIN-MERCIER, Olivier	
LEAT, Adrian	NZL						
ELDRED, Michael	USA	30	ELDRED, Michael	000 / 100 [0:10]	34	ELDRED, Michael	112 / 000 s2 [4:55]
						CALDER, Lee	

Results

- NARTEY, Emmanuel GHA
- ZENG, Qingdong CHN
- ISAEV, Mansur RUS
- ELDRED, Michael USA
- AUBIN-MERCIER, Olivier CAN
- CALDER, Lee NZL
- CHOI, Sean NZL
- LEAT, Adrian NZL





World Cup Samoa 2009

(SAM Apia, 13-14 Nov 2009)

-81 kg

13 Judoka

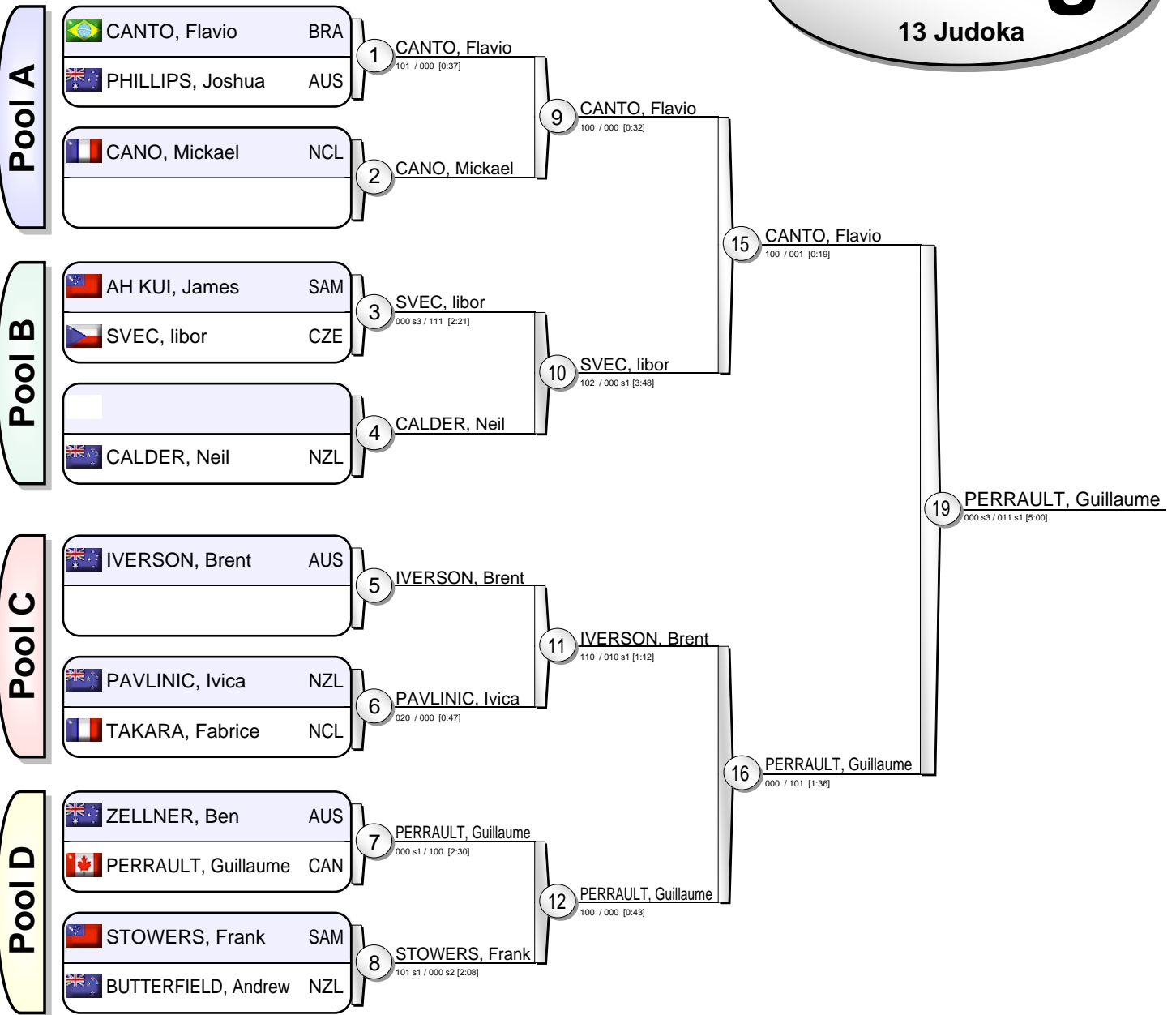

Results

1. PERRAULT, Guillaume CAN
2. CANTO, Flavio BRA
3. IVERSON, Brent AUS
3. SVEC, libor CZE
5. CALDER, Neil NZL
5. PAVLINIC, Ivica NZL
7. CANO, Mickael NCL
7. STOWERS, Frank SAM





World Cup Samoa 2009

(SAM Apia, 13-14 Nov 2009)

-90 kg

5 Judoka

	1	3	5		
1 ANTHONY, Mark AUS		✚ ₁₀	✚ ₁₀	2 (20)	
3 MATAELIGA, Pselio SAM	-		-	0 (0)	
5 PAVLINIC, Tin NZL	-	✚ ₁₀		1 (0)	

	2	4		
2 BURN, Calum NZL		✚ ₁₀		
4 BROMAN, Jonathan NZL	-			

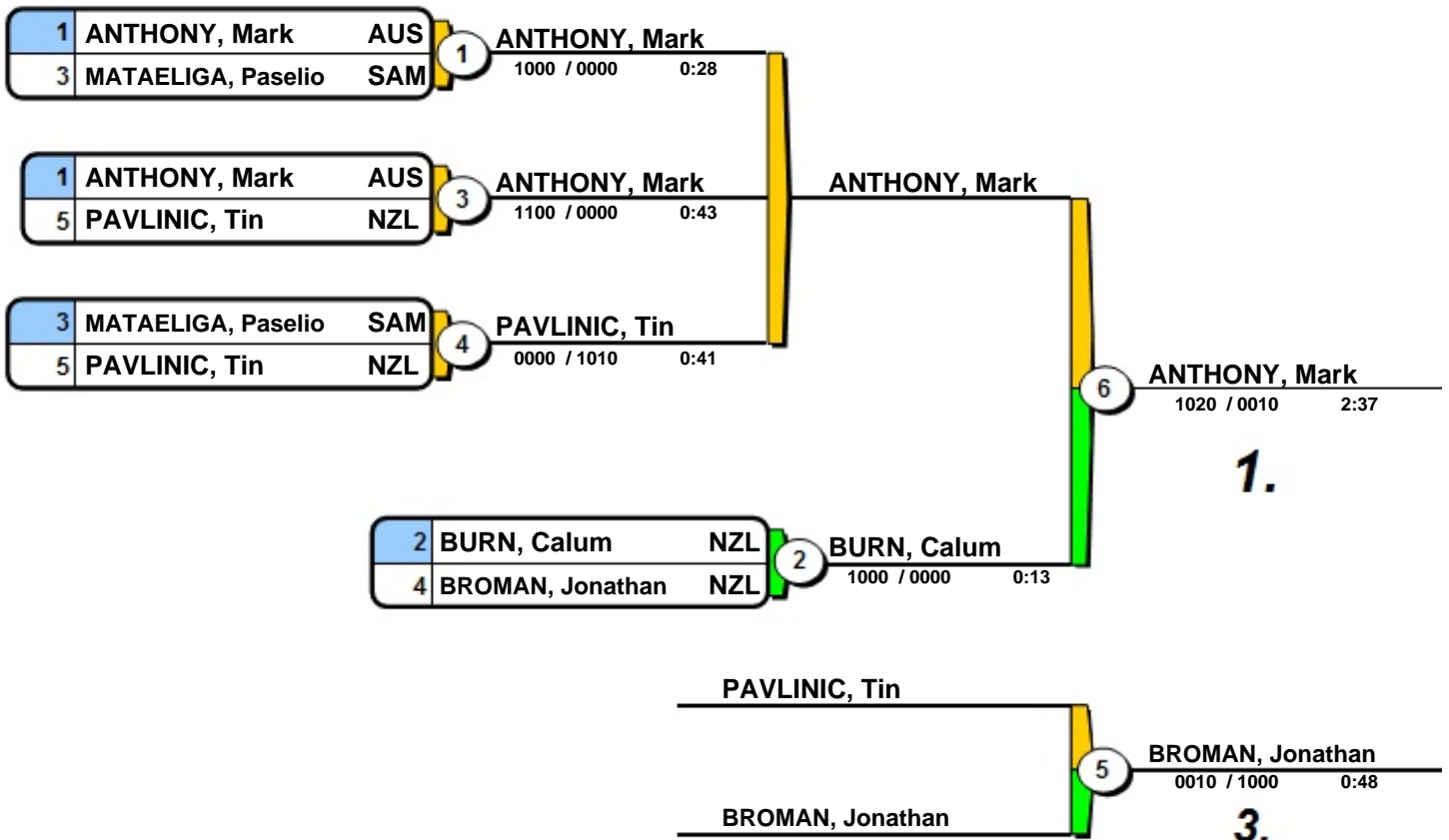

- | | | |
|----|------------------|-----|
| 1. | ANTHONY, Mark | AUS |
| 2. | BURN, Calum | NZL |
| 3. | BROMAN, Jonathan | NZL |



World Cup Samoa 2009

(SAM Apia, 13-14 Nov 2009)

-100 kg

8 Judoka

Pool A

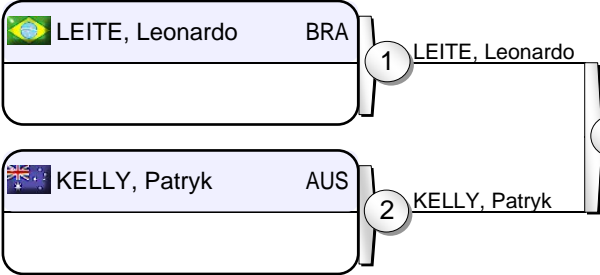

Pool B

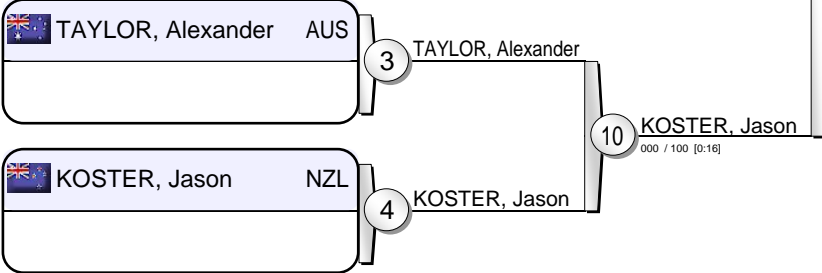

Pool C

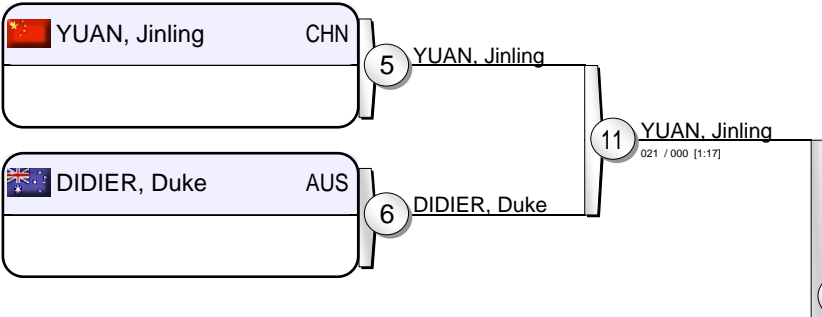

Pool D

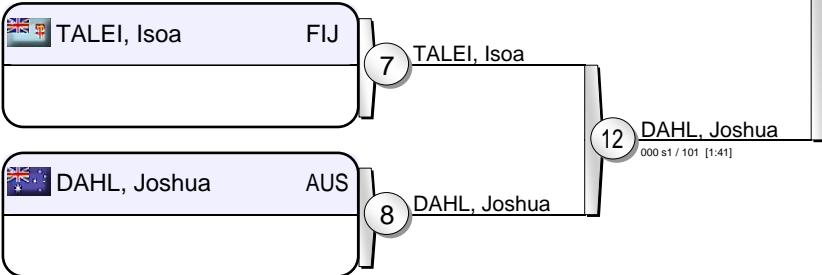

Repechage

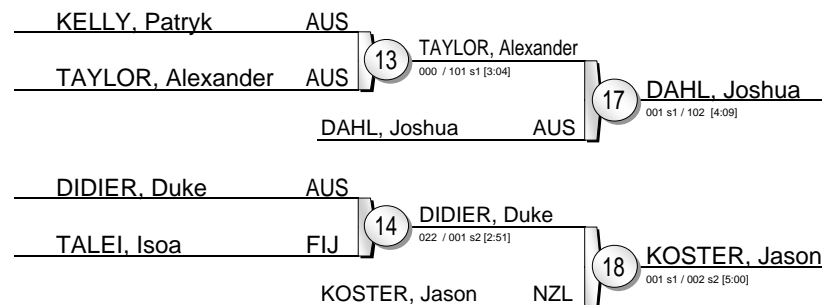

Results

1. LEITE, Leonardo BRA
2. YUAN, Jinling CHN
3. DAHL, Joshua AUS
3. KOSTER, Jason NZL
5. TAYLOR, Alexander AUS
5. DIDIER, Duke AUS
7. KELLY, Patryk AUS
7. TALEI, Isoa FIJ





World Cup Samoa 2009

(SAM Apia, 13-14 Nov 2009)

+100 kg

7 Judoka

Pool A

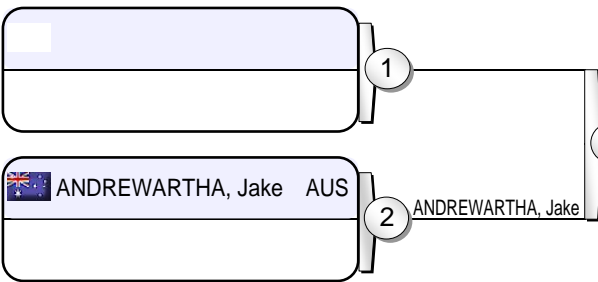

Pool B

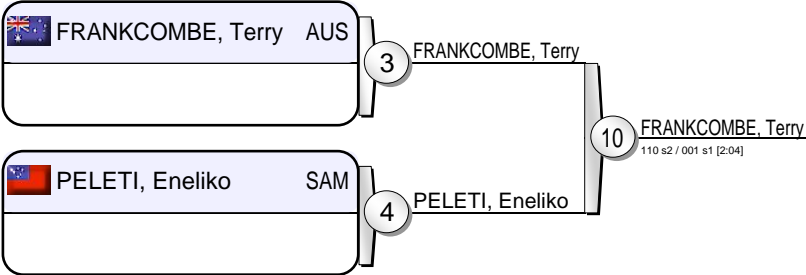

Pool C

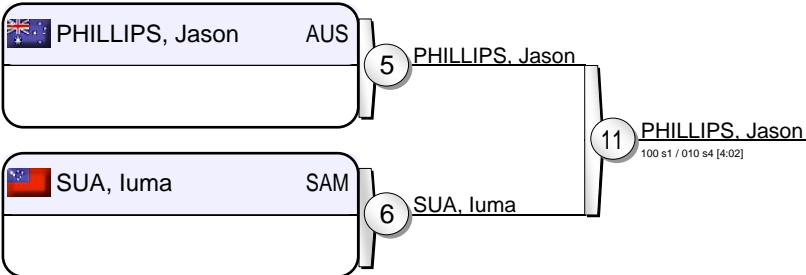

Pool D

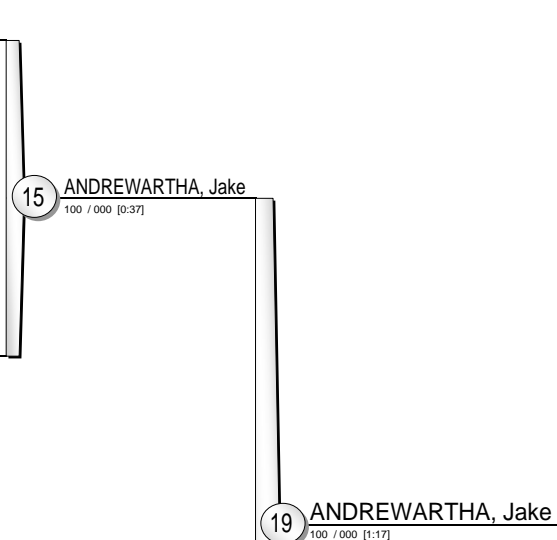
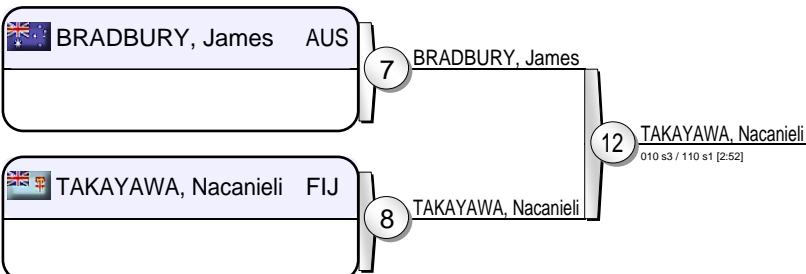

Repechage

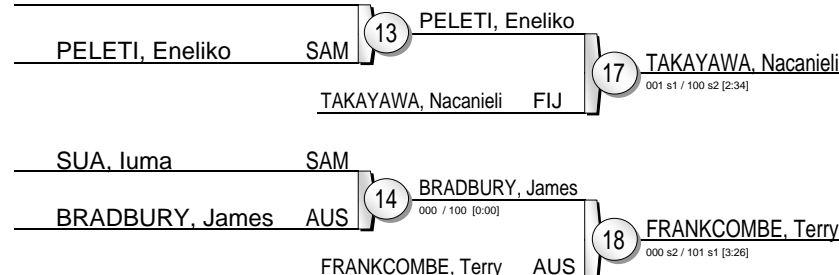

Results

1. ANDREWARTHA, Jake AUS
2. PHILLIPS, Jason AUS
3. TAKAYAWA, Nacanieli FIJ
3. FRANKCOMBE, Terry AUS
5. PELETI, Eneliko SAM
5. BRADBURY, James AUS
- 7.
7. SUA, luma SAM

